

# 2005-06 NAVY SAILING

## TABLE OF CONTENTS

### INTERCOLLEGIATE SAILING

Outlook .....2  
 Coaching Staff .....3  
 MAISA Member Schools .....3  
 Schedule .....4  
 Roster .....5  
 Midshipmen Profiles .....6-11  
 Sailing Fleet .....12  
 Individual Honors .....13

### OFFSHORE SAILING

Outlook .....14  
 Coaching Staff .....15  
 Roster .....16-17  
 Schedule .....18  
 Midshipmen Profiles .....19-21  
 Midshipmen Second Class .....22  
 Navy '44 .....23  
 Awards and Honors .....23

### THE U.S. NAVAL ACADEMY

The Naval Academy .....24-26  
 Naval Academy Facts .....27  
 Director of Athletics .....28-29  
 The Naval Academy Athletic Association ...30  
 NAAA Leaders .....31  
 Naval Academy Traditions .....32

## QUICK FACTS

### Naval Academy

Location .....Annapolis, Md.  
 Founded .....October 10, 1845  
 Enrollment .....4,000  
 Nickname .....Midshipmen, Mids  
 Colors .....Navy Blue and Gold  
 Superintendent .....  
 .....Vice Adm. Rodney P. Rempt, USN  
 Commandant .....Capt. Bruce Grooms, USN  
 Director of Athletics .....Chet Gladchuk  
 Facility .....Robert Crown Center  
 Sailing Center Phone .....410-293-5615  
 Academy Web Site .....www.usna.edu  
 Athletics Web Site .....www.navysports.com  
 Team Web Site .....www.usna.edu/SailingTeam  
 Fan Phone .....(410) 267-NAVY

## INTERCOLLEGIATE SAILING STAFF

Head Coach .....Gavin O'Hare  
 Office Phone .....(410) 293-5613  
 Dinghy Coach .....Lt. Grant Garcia  
 Office Phone .....(410) 293-2885  
 Assistant Coach .....Molly O'Bryan  
 Office Phone .....(410) 293-5617  
 Fax .....(410) 293-5233  
 Director of Finance & Admin. ...Joni Palmer  
 Office Phone .....(410) 293-5615

## OFFSHORE SAILING STAFF

Head Coach .....Jahn Tihansky  
 Office Phone .....(410) 293-5608  
 Assistant Coach .....Pete Carrico  
 Office Phone .....(410) 293-5606  
 JV Coach .....TBA  
 Office Phone .....(410) 293-5614  
 Fax .....(410) 293-5233



**Chris Forman**  
Assistant SID

## NAVY SPORTS INFORMATION STAFF

**Sailing Contact:** Chris Forman  
**Office Phone:** (410) 293-8774  
**Cell Phone:** (413) 687-4590  
**Email:** forman@usna.edu  
**Sports Information Fax:** (410) 293-8954  
**Website:** www.NavySports.com



**Scott Strasemeier**  
Assistant AD/  
Sports Information



**Stacie Michaud**  
Associate SID



**Justin Kischefsky**  
Assistant SID



**Jonathan Maggart**  
SID Intern



# OUTLOOK

The U.S. Naval Academy intercollegiate sailing team will sail in over 60 collegiate and one-design regattas during the 14-week fall and 13-week spring seasons each year. With 125 Intercollegiate Sailing Association (ICSA) member schools located in the Mid-Atlantic and New England districts Annapolis is situated just far enough south to sail late into the fall and start early each spring and is in the center of collegiate sailing's most active and competitive region.

The intercollegiate sailing team practices four days a week for three hours a day and competes every weekend in both the fall and spring. Navy's very comprehensive and competitive schedule leads to the six ICSA National Championships. Three championships are held in the fall season -- the men's single-handed, the women's single-handed and the sloops. The other three championships are held at the conclusion of the spring season -- the co-ed dinghy, the women's dinghy and team racing. When the collegiate racing season ends in the spring, many team members continue to train in the summer as crew members on the Academy's offshore racing boats, which sail and compete throughout the East Coast during the summer. With this much sailing time, it is easy to understand the old adage, "you will never be a better dinghy sailor than the day after you graduate college."

The sailing program's fleet of racing dinghies consists of 42 racing Lasers, 50 training Lasers, 22 420s, 22 Flying Juniors, three vanguard 15 dinghies, three interclub dinghies and three Tech Dinghies. This gives the team the latitude to focus during practice in a specific boat for an upcoming event. With such a large fleet, Navy is able to play host to a multitude of events every year, including two of the largest college sailing regattas in the world. The Navy Fall Intersectional and the Truxtun Umstead Regatta in the spring feature four divisions of 20 teams all racing on the water at the same time and are run by the midshipmen.

The Naval Academy's sailing facility, the Robert Crown Center, reopened after a multi-million dollar renovation and expansion was completed in March 2004. This will further allow the Navy sailing team to excel with state-of-the-art facilities and training environment.

The Intercollegiate Team at the Naval Academy has a long a long-standing history of recruiting talent and achieving results. This year is no different than those in the past. Our incoming class has some of the top recruits of the 2005 high school graduating class. Michael Curran, Kira Devers-Jones, Mac Fletcher and Andrew Vann are coming to Annapolis from Florida. Andrew Hotchkiss from Connecticut and Trisha Kutkiewicz and Paul Tucker from New York are all part of a talented freshman class. Several sailors are taking part in a post graduate year at the Naval Academy Preparatory School as well, which will allow them to compete in the 2006-07 year.

O'Hare returns two senior skippers, team captain Chuck Fulmer and John Keith. The senior crew on the team is John Appelbaum. The strong freshman class from last year will return many top skippers and crews as well, including Garth Fasano, Dave Parker, Rob Ramirez, Kristen Sproat and Mike Mullee. The co-ed team is ranked 18th in the nation and looks forward to a strong year with a lot of talent on the team.

The entire Women's team is returning from a very successful year. The women are currently ranked 10th in the country and will be looking to improve on their strong performance last season. Junior Katie Whitman and Sophomore Charlotte Hill will both be back skippering for the N.A.D.S., with sophomore crews Slava Haywas and Andrea White.

## NAVY INTERCOLLEGIATE SAILING FLEET

Lasers .....	42
Collegiate 420s .....	22
Collegiate FJs .....	22
Interclub Dinghy .....	3
Tech Dinghy .....	3
Vanguard 15 Dinghy .....	3





# HEAD COACH GAVIN O'HARE

## Fourth Year at Navy • U.S. Naval Academy '92

Gavin O'Hare enters his fourth season as head coach of the Navy intercollegiate sailing team.

Before his tenure on The Yard, O'Hare served as a coach and instructor for San Diego State and Washington, as well as for the local Severn Sailing Association. O'Hare has also led training clinics and seminars for youth and adult programs in

Canada, Japan and throughout the United States.

As a member of the US SAILING Hinman Committee and U.S. Team Racing Association, he is recognized as a team-racing expert and has authored a book on tactics and strategy entitled Contemporary Team Racing.

O'Hare is a US SAILING certified level one instructor and level

two coach, and continues to gain competitive sailing experience by racing small sailboats such as Snipes, Vanguard 15s and Lasers. He received the 2002 US SAILING Leadership Award for excellence in promoting team racing.

He adds six years of sales and marketing experience after earning his master's degree in business administration from the University of Phoenix in 2003.

O'Hare returns to Annapolis after graduating from the Naval Academy in 1992. During his time at Navy, he was a member of the intercollegiate sailing program, which was coached by current Olympic sailing team coach, Gary Bodie. After graduation, he served as a surface warfare officer in operations and engineering billets aboard the USS OLDENDORF (DD 972) and the USS PONCE (LPD 15).

## ASSISTANT COACHES



### GRANT GARCIA

ASSISTANT COACH  
SECOND SEASON

Lieutenant Grant Garcia enters his second season as an assistant coach on the intercollegiate sailing team. He was born in Miami, Fla, on August 1, 1978, and graduated from the Naval Academy in May 2000 with a Bachelor of Science in General Science and his commission.

While at the Academy, Grant sailed for the Intercollegiate Team and was selected to the All American Team – Honorable Mention in 1999. Since graduation, Grant has coached sailors up and down the eastern seaboard during his spare time. After completing nuclear power and basic submarine training, he reported to USS BOISE (SSN 764), homeported in Norfolk. During this tour, he served in a variety of division officer assignments, earned his submarine gold dolphins, participated in a Mediterranean deployment as well as in Iraqi Freedom.

He returns to the Naval Academy for his two-year shore duty tour in support of Robert Crown Center – Intercollegiate Team Operations.



### MOLLY O'BRYAN

ASSISTANT COACH  
THIRD SEASON

Molly O'Bryan enters her third season as a Naval Academy Dinghy Sailing Team assistant coach. A 2002 graduate of the University of Hawai'i at Manoa, O'Bryan competed on the UH varsity women's and co-ed sailing teams. She has competed in nine intercollegiate National

Championships (five women's, two co-ed, and two team racing) and is a two-time ICSA All-American.

O'Bryan was a member of the 2003 US SAILING Team and recently completed a 470 Olympic campaign. She is also a US SAILING Level I instructor.

Molly grew up sailing in San Diego, Calif. and competes in both dinghies and keelboats. She recently competed in non-470 events, including the US SAILING Women's National Championship and the Rolex International Women's Keelboat Championships.

O'Bryan comes to Annapolis after working for the U.S. Marine Corps Community Services as head of the sailing program at Kaneohe Bay

## MID-ATLANTIC INTERCOLLEGIATE SAILING ASSOCIATION (MAISA) MEMBER SCHOOLS

Christopher Newport  
Colgate  
Columbia  
Cornell  
Delaware  
Drexel  
Fordham

George Washington  
Georgetown  
Hamilton  
Hampton  
Haverford/Bryn Mawr  
Hobart & William Smith  
Loyola (Md.)

Maryland  
Old Dominion  
Pennsylvania  
Penn State  
Princeton  
Queen's (Canada)  
Rochester

Salisbury  
St. Mary's (Md.)  
Stevens Institute  
SUNY-Maritime  
Syracuse  
UMBC  
U. S. Merchant Marine

Academy  
U. S. Military Academy  
**U. S. Naval Academy**  
Virginia  
Vassar  
Washington (Md.)  
Webb Institute

# SCHEDULE

## Fall 2005

Sept. 3-4	at Anderson Trophy
Sept. 3-4	at KP Laser Open
Sept. 10-11	at Captain Hurst Bowl
<b>Sept. 10-11</b>	<b>Navy Laser Open</b>
Sept. 10-11	at Riley Cup
Sept. 10-11	at Old Dominion BYO Radial
Sept. 17-18	at Mrs. Hurst (WM's)
Sept. 17-18	at Nevins Trophy
Sept. 17-18	at Freshmen / New Sailor Groundbreaker
<b>Sept. 24-25</b>	<b>Shields Trophy</b>
<b>Sept. 24-25</b>	<b>Laser Qualifier South</b>
Sept. 24-25	at SMC Open for the Senators Cup / South Fall #1
<b>Sept. 24-25</b>	<b>MAC Cup Elims</b>
Oct. 1-2	at Danmark Trophy
<b>Oct. 1-2</b>	<b>MAISA Sloops</b>
Oct. 1-2	at Tom Curtis / South Fall #2
<b>Oct. 1-2</b>	<b>Navy Small Keelboat Promotional</b>
<b>Oct. 8-9</b>	<b>Navy Fall Women's Intersectional</b>
Oct. 8-9	at Hobart / WS Fall Intersectional
Oct. 8-9	at MAISA Men's Singlehanded's Can Van Duyn Trophy
<b>Oct. 15-16</b>	<b>Navy Fall Intersectional</b>
Oct. 15-16	at Yale Women's Intersectional
Oct. 22-23	at Hoyt Trophy
Oct. 22-23	at Stu Nelson
<b>Oct. 22-23</b>	<b>McMillan Cup</b>
<b>Oct. 22-23</b>	<b>MAISA Women's Singlehanded's Faye Bennet Trophy</b>
Oct. 22-23	at KP Dinghy Open
Oct. 28-30	at Cornelius Shields Trophy / ICSA Sloops
Oct. 29-30	at Women's Victorian Coffee Urn
Oct. 29-30	at War Memorial
Nov. 5-6	at Atlantic Coast Freshmen
Nov. 5-6	at MAISA Women's Fall Dinghy
Nov. 12-13	at Atlantic Coast Tournament
Nov. 12-13	at Atlantic Coast Women
Nov. 12-13	at Atlantic Coast Dinghy
Nov. 18-20	at ICSA Men's Singlehanded NA's
Nov. 18-20	at ICSA Women's Singlehanded NA's
Nov. 25-27	at Timme-Angsten
Dec. 30-31	at Sugar Bowl
Dec. 30-31	at Sugar Bowl Women's
Jan. 7-8	at Rose Bowl

## Spring 2006

Jan. 21-22	at Rainbow Intersectional
Feb. 11-12	at Old Dominion Scrimmage
Feb. 11-12	at Charleston Women's
<b>Feb. 18-19</b>	<b>Navy Scrimmage</b>
Feb. 23-26	at Laser Midwinter Eastern Championships
Feb. 25-26	at Saint Mary's College Scrimmage
March 5-6	at MAISA Team Race
March 5-6	at Old Dominion Spring Open
March 5-6	at John Jackson Memorial Team Race
March 11-12	at Admiral Moore
March 11-12	at Laser Midwinter Western Championships
<b>March 11-12</b>	<b>Navy Spring Women's Intersectional</b>
March 11-12	at Saint Mary's Team Race Intersectional
<b>March 18-19</b>	<b>Truxtun Umsted</b>
March 18-19	at Saint Mary's Women's Intersectional
March 25-26	at Owen Trophy
March 25-26	at Lynn Marchiando Team Race
<b>March 25-26</b>	<b>Atlantic Coast Mono's</b>
March 25-26	at Aaron Szambecki Team Race Intersectional
<b>March 25-26</b>	<b>Team Race Challenge</b>
April 1-2	at Boston Dinghy Cup (Four double-handed divisions)
April 1-2	at Women's Duplin Trophy
April 1-2	at Intrepid Trophy
April 1-2	at Hobart / William Smith - North Spring No. 1
April 1-2	at Ocean County Spring Open - Central No. 2
April 8-9	at Ted Ferrarone Team Race
April 8-9	at Washington College Women's Open
April 8-9	at Maryland Spring Open
April 8-9	at MAISA Team Race / Capt. Prosser Trophy
April 8-9	at Washington College Women's Open
April 15-16	at Women's Dellenbaugh Trophy
<b>April 15-16</b>	<b>Kennedy Cup</b>
April 15-16	at Admiral's Cup
April 15-16	at New York Maritime - North Spring No. 2
<b>April 15-16</b>	<b>Navy Small Keelboat Promotional Invite</b>
April 22-23	at Thompson Trophy
April 22-23	at MAISA Women's Championship
April 22-23	at MAISA Freshman Open
April 22-23	at Delaware Spring Open
April 29-30	at America Trophy
May 6-7	at America Trophy (Make-up date)
May 24-26	at ISCA Women's / Gerald Miller Trophy
May 28-30	at ISCA Team Race / Walter Wood Trophy
May 31-June 2	at ISCA Dinghy / Henry A. Morss Trophy

**Navy hosts meets in bold.**

# ROSTER

Name	Yr.	Hometown/High School	Major
Jameson Adler	Sr.	Rockville Centre, N.Y./South Side	Economics
John Appelbaum	Sr.	Florissant, Mo./Hazelwood Central	Computer Science
Krysta Anthony	So.	Tullahoma, Tenn./Tullahoma	Systems Engineering
Andrea Bosch	So.	Belize City, Belize/St. Catherine Academy	Computer Science
Amanda Burney	So.	Indianapolis, Ind./Park Tudor	Mechanical Engineering
Audrey Callanan	So.	Laguna Niguel, Calif.	Mathematics
Alexander Campbell	So.	Santa Barbara, Calif./Dos Pueblos	Quantitative Economics
Daniel Conley	Jr.	Waco, Texas/Midway	Chemistry
John Fasano	So.	Briarcliff Manor, N.Y./St. George's	Economics
Charles Fulmer	Sr.	Seminole, Fla./Admiral Farragut Academy	General Science
Ian Gill	So.	Norwalk, Conn./Norwalk	Ocean Engineering
Gary Grimes	Jr.	Newport Beach, Calif./Newport Harbor	Economics
Slava Haywas	Jr.	Oceanside, Calif./El Camino	English
Charlotte Hill	So.	Miami, Fla./Ransom Everglades	Oceanography
John Keith	Sr.	Kenilworth, Ill./New Trier	Political Science
John Leone	So.	Voorhees, N.J./Eastern	Aerospace Engineering
Catherine Long	Jr.	Hopkinton, Mass./St. Mark's	Ocean Engineering
Lindsey Magee	Jr.	Manasquan, N.J./Manasquan	Oceanography
Kevin McGill	So.	Barrington, R.I./Barrington	Naval Architecture
Michael Mullee	So.	Huntington Beach, Calif./Edison	English
Adam Oliveira	Sr.	Fairhaven, Mass./Tabor Academy	Naval Architecture
David Parker	So.	Erie, Pa./Cathedral Prep	Economics
Kevin Peartree	So.	Rochester, N.Y./McQuaid Jesuit	History
Robert Ramirez	So.	Miami, Fla./Gulliver Prep School	Economics
Margaret Reynolds	So.	Westfield, N.J./Westfield	Naval Architecture
Jeffrey Sharp	Jr.	Bradenton, Fla./Manatee	Aerospace Engineering
Cullen Shaughnessy	So.	Marco Island, Fla./Community School of Naples	Economics
Sarah Shewmaker	So.	Short Hills, N.J./Millburn	Physics
Kristen Sproat	So.	Berwyn, Pa./Villa Maria Academy	Systems Engineering
Lauren Sutehall	Jr.	Duluth, Ga./Chattahoochee	Economics
Kristen Ullman	Jr.	Wellington, Fla./Suncoast	Aerospace Engineering
Andrea White	Jr.	Diamondhead, Miss./Hancock	Information Technology
Katherine Whitman	Jr.	Folly Beach, S.C./Tabor Academy (Mass.)	Oceanography

**\*\* Freshmen will not be known until later in the season.**

**Head Coach:** Gavin O'Hare

**Assistant Coaches:** Grant Garcia, Molly O'Bryan

**Officer Representative:** Frances Clemens

**Faculty Representative:** Prof. Paul Miller

# MIDSHIPMEN PROFILES



## JOHN APPELBAUM

**SENIOR  
FLORISSANT, MO.**

At Navy: 2004-05 — Sailed in 15 regattas... won inaugural Senator's cup crewing in B division... helped Mids qualify for ICOSA Sloop Nationals... helped team to a second place finish at Truxtun

Umsted Regatta... winner of the Julia Babineau Top Intercollegiate Crew Award.

2003-04 — Sailed in nine regattas... crewed the B division boat for Navy as the Mids took 15th at the Captain Hurst Bowl

2002-03 — Sailed in eight regattas.

Prior to Navy: 2002 graduate of Hazelwood Central High School... member of the swimming team... biggest athletic thrill was reaching 30 knots in a 420... plays clarinet and saxophone... nicknamed Apples.

Personal: Son of Theodore and Susan Appelbaum... has two sisters and one brother... born Aug. 15, 1983... majoring in Computer Science.



## CHARLES FULMER

**CAPTAIN  
SENIOR  
SEMINOLE, FLA.**

At Navy: 2004-05 — Sailed in 13 regattas... won B division at Senator's Cup... placed sixth at MAISA Singlehandeds... finished third in D division at the Truxtun Umsted Regatta.

2003-04 — Sailed in five regattas... took fourth place at the Atlantic Coast Monohull Championship.

2002-03 — Sailed in 12 regattas... finished in seventh place at the APS Laser Atlantic Coast Championship in a field of more than 100 sailors in May 2003... helped the Mids to a third-place finish at the Kings Point Spring Open/North No. 1 Regatta in March 2003.

Prior to Navy: 2002 graduate of Admiral Farragut Academy... member of the cross country team... began sailing at the age of eight out of Clearwater Yacht Club... finished as the top American at three youth world championships... enjoys building robotics... lists surfing down huge waves in 30 knots in a laser as his biggest athletic thrill

Personal: Son of Cassie Featherston... born Nov. 2, 1983... majoring in General Science.



*Charles Fulmer*



## JOHN KEITH

**SENIOR**  
KENILWORTH, ILL.

At Navy: 2004-05 — Sailed in 17 regattas...skipped boat that qualified for ICSA Sloop Nationals...represented team sailing B division and on team racing team...winner of Rusty Cavileer

Doublehanded MVP Award.

2003-04 — Sailed in 16 regattas...helped the Mids to a second-place showing at the Nevins Trophy in Oct. 2003...skipped the A division boat for Navy as the Mids took 15th at the Captain Hurst Bowl in Sept. 2003...finished second in A division at the HWS Fall Intersectional...2002-03—Sailed in 12 regattas...finished fourth in B division at the Freshman Atlantic Coast Championship.

Prior to Navy: 2002 graduate of New Trier High School...member of the lacrosse and sailing team...competed with the Chicago Yacht Club during high school... lists the camaraderie combined with great competition as reasons he likes sailing.

Personal: Son of Robert and Susan Keith... has one sister and two brothers... born April 12, 1984... majoring in Political Science.



## DANIEL CONLEY

**JUNIOR**  
WACO, TEXAS

At Navy: 2004-05 — Competed in four regattas... sailed to seventh place crewing in B division at the Riley Cup.

2003-2004 — Competed in five regattas.

Prior to Navy: Graduate of Midway High School...National Honors Society...National Thesbian Society member...lists joining the Navy as the craziest thing he's ever done.

Personal: Son of Charles and Virginia Conley...has one brother and two sisters...born April 27, 1985...majoring in chemistry.



## GARY GRIMES

**JUNIOR**  
NEWPORT BEACH, CALIF.

At Navy: 2004-05 — Sailed in 10 regattas...did bow on the boat that qualified for ICSA Sloop North Americans.

2003-04 — Sailed in 17 regattas...helped the Mids to strong performances at three freshmen events, including a third-place finish at the Freshman Groundbreaker in Sept. 2003 and a sixth-place showing at the MAISA Freshman Championship in Oct. 2003.

Prior to Navy: 2002 graduate of Newport Harbor High School... lettered in soccer and sailing... claimed the sailing team national championship in 1999 and 2000... named his soccer team's Defensive Player of the Year as a senior... lists Frank Tybor as his favorite athlete.

Personal: Son of Gary and Sharon Grimes ...has two sisters and one brother... born August 14, 1984... majoring in economics.

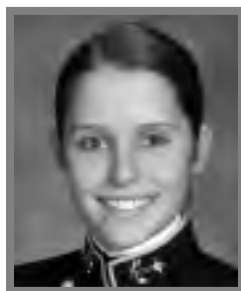

## SLAVA HAYWAS

**JUNIOR**  
OCEANSIDE, CALIF.

At Navy: 2004-05 — Sailed in 13 regattas...crewed on women's A division boat that qualified for ICSA Women's North American's.

2003-04 — Sailed in 13 regattas...sailed with captain Justin Smith to a fifth-place finish in the A division at The War Memorial Regatta as the Mids took seventh overall in Nov. 2003... helped the Mids to a second-place finish at the Nevins Trophy in Sept. 2003.

Prior to Navy: 2002 graduate of El Camino High School ... lettered in gymnastics and cross country ... served as team captain of her gymnastics squad all four years ... named MVP of both teams as a senior...lists boxing and wrestling as her favorite classes at the Academy...enjoys the sportsmanship and camaraderie of sailing.

Personal: Daughter of Askold and Nadia Haywas... has two brothers... born April 19, 1985... majoring in English.



## LINDSEY MAGEE

**JUNIOR**  
**MANASQUAN, N.J.**

At Navy: 2004-05 — Competed in nine regattas.

2003-2004 — Sailed in 12 regattas...helped Women's team qualify for the ICSA Women's North American's

and finish third overall, fifth in B division... crewed the B division boat to a first place finish at the Women's Atlantic Coast Championship... also crewed the B division boat to a first place finish at the Navy Fall Women's Intersectional as the Mids took third overall in Oct. 2003.

Prior to Navy: 2003 graduate of Manasquan High School... helped swimming team to back-to-back conference titles in 2000 and 2001... sailed at the Toms River Yacht Club... lists her sister Courtney as her role model... nicknamed Clay.

Personal: Daughter of Timothy and Bonnie Magee ... born Feb. 24, 1985... majoring in English, Arabic and German.



## JEFFREY SHARP

**JUNIOR**  
**BRADENTON, FLA.**

At Navy: 2004-05 — Sailed in three regattas... helped team to a second place finish at Truxtun Umstead Regatta.

2003-04 — Sailed in two regattas... skippered the B division boat at the

Atlantic Coast Freshmen Championship in Nov. 2003.

Prior to Navy: 2003 graduate of Manatee High School... lists sailing a laser on the outside break of Clearwater Beach during hurricane season as his biggest athletic thrill.

Personal: Son of Jeffrey Sr. and Michelle Sharp ... has two sisters... born Aug. 28, 1985... majoring in Aerospace Engineering.



**Jeff Sharp**



**Lauren Sutehall**

## LAUREN SUTEHALL

**JUNIOR**  
**DULUTH, GA.**

At Navy: 2004-05 — Competed in 17 regattas... won MAISA Women's Fall Championship as crew in B division... crewed in co-ed B division boat all year as well as on team racing team...

crewed for women's A division boat at ICSA Women's North Americans.

2003-04 — Sailed in seven regattas... crewed the B division boat at the Atlantic Coast Freshmen Championship in Nov. 2003... helped the Mids take fifth place at the Yale Women's Regatta in Oct. 2003.

Prior to Navy: 2001 graduate of Chattahoochee High School... transferred to Navy from Georgia Tech... competed on the crew and swimming teams... helped her crew team to the Southeast Regional title and a 12th-place finish at Nationals in 2001...enjoys traveling and winning with the sailing team... nicknamed LoLo.

Personal: Daughter of John and Susan Sutehall... has two brothers and one sister... born Oct. 9, 1984... majoring in economics



## KRISTEN ULLMAN

**JUNIOR**  
WELLINGTON, FLA.

At Navy: 2005 — Competed in eight regattas... helped women's team to a 10th place finish at ICSA Women's North Americans.

Prior to Navy: Graduate of Suncoast High School... varsity diving team captain... State qualifier in diving all four years

Personal: Daughter of Keith and Debbie Ullman... has one sister... born April 12, 1985... majoring in aerospace engineering.



## ANDREA WHITE

**JUNIOR**  
DIAMONDHEAD, MISS.

At Navy: 2004-05 — Sailed in 16 regattas... finished third at Mrs. Hurst Regatta crewing in B division... tied for first at Duplin Regatta... finished ninth in B division at ICSA Women's North

Americans.

2003-04--Competed in one regatta.

Prior to Navy: 2003 graduate of Hancock High School... member of the swimming and tennis squads... captained the swim team as a senior... salutatorian of her graduating class... lists coming to the Naval Academy as the craziest thing she's ever done... likes being on the water.

Personal: Daughter of John and Brenda White... has one brother... born Sept. 14, 1984... majoring in information technology.



## KATHERINE WHITMAN

**JUNIOR**  
FOLLY BEACH, S.C.

At Navy: 2004-05 — Sailed in 20 regattas... finished second in A division as skipper at Mrs. Hurst Regatta...

helped team win the MAISA Women's Fall Championship, finishing third in A division... skippered on team racing team... finished seventh in A division at ICSA Women's North Americans.

2003-04 — Sailed in 14 regattas... helped team qualify and place third at ICSA Women's North American Championship... skippered the B division boat to a first-place finish at the Women's Atlantic Coast Championship in Nov. 2003... also skippered the B division boat to a first place finish at the Navy Fall Women's Intersectional as the Mids took third overall in Oct. 2003.

Prior to Navy: 2003 graduate of the Tabor Academy in

Marion, Mass. ... competed on the sailing, cross country, soccer and ice hockey teams... was captain of her ice hockey team as a junior, sailing team captain as senior... lists Assistant Coach Molly O'Bryan as her favorite athlete and her dad as the most influential person in her life.

Personal: Daughter of Bill and Fran Whitman... has two brothers... born Jan. 9, 1985... majoring in oceanography.



## KRYSTA ANTHONY

**SOPHOMORE**  
TULLAHOMA, TENN.

At Navy: 2004-05 — Sailed in three regattas... won B division at KP Dinghy Open as crew... finished second overall crewing the A division at the Arrigan Memorial.

Prior to Navy: 2004 graduate of Tullahoma High School... valedictorian... National Honors Society member... drum major of high school marching band... varsity letter winner in track, soccer and cross country... Sports Illustrated All American Teen... lists Julie Foudy as her favorite athlete... enjoys traveling, sleeping and running in her free time.

Personal: Daughter of Jack and Patty Anthony... has one brother... born Aug. 10, 1985.

*Cullen Shaughnessy and Krysta Anthony*





## ANDREA BOSCH

SOPHOMORE  
BELIZE CITY, BELIZE

At Navy: 2004-05 — Sailed in two regattas.

Prior to Navy: Graduate of St. Catherine Academy... attended one year at St. John's Junior College... Class

President... Treasurer of School Sport Club... Canoe Club member... lists Rick Bateman, her Karate instructor, as a role model... has twin brother that also attends the Academy... once canoed 170 miles in a four-day race.

Personal: Daughter of Javier and Sadia Bosch... has one sister and two brothers... born Aug. 10, 1984.



## AMANDA BURNEY

SOPHOMORE  
INDIANAPOLIS, IND.

At Navy: 2004-05 — Sailed in six regattas ... helped team to 1st place finish at KP Dinghy Open... won A division at the Delaware Spring Open... finished second overall at HWS Spring

Series.

Prior to Navy: Attended Park Tudor High School... varsity volleyball team captain... Girl Scout Gold Award winner... waterski state record holder and U.S. National Team member... lists her biggest athletic thrill as ski jumping 100 feet for the first time... enjoys competitive waterskiing in her off-time

Personal: Daughter of Bryan and Virginia Burney... has two brothers... born Feb. 22, 1986.



## AUDREY CALLANAN

SOPHOMORE  
LAGUNA NIGUEL, CALIF.

At Navy: 2004-05 — Sailed in seven regattas during fall season.

Prior to Navy: 2004 graduate of Dana Hills High School... valedictorian... AP Scholar... enjoys reading in her

free time... lists getting double bullets in a set this past fall as biggest athletic thrill... sees fellow Mid Charlotte Hill as her favorite athlete.

Personal: Daughter of Gerry and Judy Callanan... has one sister... born July 29, 1986... majoring in mathematics.



## ALEXANDER CAMPBELL

SOPHOMORE  
SANTA BARBARA, CALIF.

At Navy: 2004-05 — Sailed in six regattas... skippered B division at ODU Spring Open to a third place finish.

Prior to Navy: Attended Dos Pueblos High School... National Merit Finalist... Eagle Scout... favorite pastime is playing Frisbee, miniature golf and eating peanuts... lists claiming to be heir of Campbell Soup family to crash a formal ball as one of his craziest moments.

Personal: Son of Douglas and Regula Campbell... has one brother... born Nov. 13, 1986... majoring in quantitative economics.

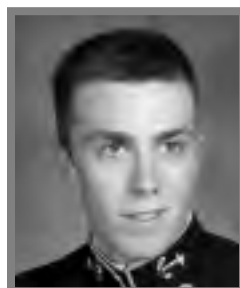

## GARTH FASANO

SOPHOMORE  
BRIARCLIFF, N.Y.

At Navy: 2004-05 — Sailed in 18 regattas... helped team finish 2nd at Freshman ACC's, finished fifth in B division at Co-ed ACC's... helped team to second-place finish at Truxtun Umsted

Regatta sailing A division... skippered on team racing team.

Prior to Navy: 2004 graduate of St. George's High School ... sailing team captain... finished third at High School Team Race National Championship in 2003 and 2004... lists Sir Peter Blake as favorite athlete... can speak Chinese fluently...e njoys the freedom that sailing gives.

Personal: Son of JP and Mary Beth Fasano... born April 22, 1986... majoring in economics.



Garth Fasano



## IAN GILL

**SOPHOMORE  
NORWALK, CONN.**

At Navy: 2004-05 — Sailed in seven regattas... won the Delaware Spring Open.

Prior to Navy: 2004 graduate of Norwalk High School... member of

National Honor Society... sailed for Cedar Point Yacht Club... lists juggling as a random talent... was once struck by lightning while sailing.

Personal: Son of Harrison and Patricia Gill... has three brothers and one sister... born Aug. 27, 1986... majoring in ocean systems.

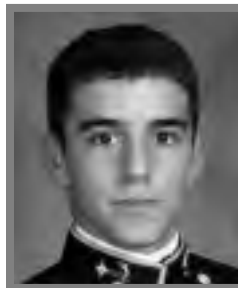

## JOHN LEONE

**SOPHOMORE  
VOORHEES, N.J.**

At Navy: 2004-05 — Sailed in four regattas... helped team place second overall at the Freshman Atlantic Coast Championship... won the Delaware Spring Open.

Prior to Navy: 2004 graduate of Eastern High School ... enjoys playing baseball in free time... sees his father as the most influential person in his life for his endless support.

Personal: Son of John Jr. and Sandra Leone... has one sister...born Aug. 27, 1986... majoring in aerospace engineering.



## CHARLOTTE HILL

**SOPHOMORE  
MIAMI, FLA.**

At Navy: 2004-05 — Sailed in 18 regattas... finished fourth at MAISA Women's Singlehanded's... skippered B division boat to win MAISA Women's Fall Championship... tied for first in B

division at Duplin regatta... finished ninth in B division at ICSEA Women's North Americans... winner of the Fair American Intercollegiate Female MVP Award...

Prior to Navy: 2004 graduate of Ransom Everglades High School... member of the soccer team, Key Club and Student Government... captain of sailing team... helped team win team racing and fleet racing national qualifiers her junior year... won Leiter Cup in 2003... member of 2001 European Opti Team... learned to sail at Miami Yacht Club and raced out of Coral Reef Yacht Club... sees Gary Jobson as her role model... biggest athletic thrill was port tacking a 500 boat fleet and making it.

Personal: Daughter of Mary Kennerk and Dwight Hill... has two sisters... born Aug. 14, 1986...majoring in oceanography.



*John Leone and Kevin Peartree*



**KEVIN MCGILL**

**SOPHOMORE  
BARRINGTON, R.I.**

At Navy: 2004-05 — Sailed in two regattas.

Prior to Navy: 2004 graduate of Barrington High School... National Honor Society member... varsity hockey player... sailed for Barrington Yacht Club as a junior... favorite athlete is Wayne Gretzky... likes that nothing is ever the same with sailing.

Personal: Son of David and Peggy McGill... has two brothers... born Aug. 30, 1986... majoring in Naval Architecture.



**MICHAEL MULLEE**

**SOPHOMORE  
HUNTINGTON BEACH, CALIF.**

At Navy: 2004-05 — Sailed in nine regattas... finished second at Freshman Atlantic Coast Championship crewing in B division... won B division three weekends in a row in the Spring Semester.

Prior to Navy: Graduate of Edison High School... lists Ken Ammann as the most influential person in his life... in 2002-2003 was personal page to the Speaker of the House of Representatives, Dennis Haster... won the Crew of Two Around Catalina in 2002... Eagle Scout.

Personal: Son of Bill and Francine Mullee...has two brothers and two sisters... born Sept. 23, 1985... majoring in English.



**DAVID PARKER**

**SOPHOMORE  
ERIE, PA.**

At Navy: 2004-05 — Sailed in 13 regattas... helped team to 1st place finish at KP Dinghy Open... won A division at the Delaware Spring Open... was a valuable heavy air crew for major

co-ed events.

Prior to Navy: 2002 graduate of Cathedral Prep High School... worked for Americorps for one year ... sailed out of Erie Yacht Club as a junior... lists yodeling as a random talent... enjoys marathon running.

Personal: Son of Mike and Diane Baughman... has two sisters and three brothers... born Dec. 21, 1983... majoring in economics.



**KEVIN PEARTREE**

**SOPHOMORE  
ROCHESTER, N.Y.**

At Navy: 2004-05 — Sailed in eight regattas.

Prior to Navy: 2004 graduate of McQuaid Jesuit High School... 1st Honors... lists Captain Winters, U.S.A., as his role model... was once chased by a bear.

Personal: Son of David and Audrey Peartree... has one brother and one sister... born Jan. 20, 1986... majoring in history.

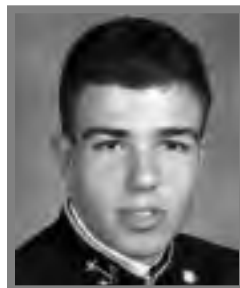

**ROBERT RAMIREZ**

**SOPHOMORE  
MIAMI, FLA.**

At Navy: 2004-05 — Sailed in nine regattas... helped team to second-place finish at Freshman ACC's... won B division three weekends in a row in spring semester.

Prior to Navy: 2004 graduate of Gulliver Prep School ... likes sailing because it is such a multi-dimensional sport that one can do for their entire life... lists Augie Diaz as his role model.

Personal: Son of Daniel and Carmen Ramirez... born March 5, 1986... majoring in economics.

*Robert Ramirez and Michael Mullee*





## MARGARET REYNOLDS

SOPHOMORE  
WESTFIELD, NJ

At Navy: 2004-05 — Sailed in four regattas...finished second at Washington College Women's Open skippering B

division.

Prior to Navy: 2004 graduate of Westfield High School... National Honors Society... sailed out of Island Heights Yacht Club in New Jersey... lists her grandfather as her role model... likes how relaxing but competitive sailing is.

Personal: Daughter of Phil and Margarita Reynolds... has three brothers...born June 12, 1986...majoring in Naval Architecture.



## SARAH SHEWMAKER

SOPHOMORE  
SHORT HILLS, N.J.

At Navy: 2004-05 — Sailed in one regatta.

Prior to Navy: Graduated from

Millburn High School.

Personal: Daughter of Bruce and Patricia Shewmaker... born Feb. 9, 1985... majoring in physics.



## KRISTEN SPROAT

SOPHOMORE  
BERWYN, PA.

At Navy: 2004-05 — Sailed in 15 regattas... crewed in A division at Freshman ACC's finishing second... crewed at Co-ed ACC's finishing 5th in B division... helped team to second-

place finish at Truxtun Umsted Regatta... crewed in A division boat all Spring as well as team racing team... winner of the Williams Seamanship Most Improved Award.

Prior to Navy: 2004 graduate of Villa Maria Academy in Melvern... student body president... valedictorian... music honor society president... lacrosse academic All-American... plays the viola... enjoys pick-up soccer and Frisbee... likes the intense mental concentration combined with the physical demands sailing provides

Personal: Daughter of Ward and Heidi Sproat... has two brothers...born May 3, 1986... majoring in systems engineering.



## CULLEN SHAUGHNESSY

SOPHOMORE  
MARCO ISLAND, FLA.

At Navy: 2004-05 — Sailed in five regattas... won B division at KP Dinghy Open... finished second overall at the

Arrigan Memorial skippering A division... finished second overall at HWS Spring Open skippering A division.

Prior to Navy: Graduated from Community School of Naples.

Personal: Son of Mark and Sue Shaughnessy... has one brother... born Aug. 5, 1986...majoring in economics.

### NAVAL ACADEMY FACTS NAVY SAILING

- Education valued at \$275,000
- The Navy pays tuition, room and board, medical and dental, and provides active-duty military benefits
- Midshipmen receive a salary (\$699/month) used for laundry, barber, activities, yearbook, clothing, etc.
- 30 days paid vacation plus holidays per year
- 18 diverse majors
- Trident Scholar and Voluntary Graduate Education Programs
- Naval Academy Faculty comprised of 50% Civilian and 50% Military
- Student-Faculty ratio is less than 8-to-1 (ranked as one of the most accessible)
- Individual lecture halls and small labs

Find more info about the Naval Academy by visiting our website:  
<http://www.usna.edu/>

Find more info about the Naval Academy Admissions by visiting our website:  
<http://www.usna.edu/Admissions/>

### NAVY SAILING TEAM FACTS

- Navy Academy Sailing Program-Fleets
- 136 Lasers
- 22 FJ's
- 22 420's
- 3 Larks
- 3 Inter Clubs
- 3 Vanguard 15's
- 12 J24's
- 20 Colgate 26's
- 20 Navy 44 Foot Sloops
- Several Grand Prix Sloop Offshore Racers
- 71 All-America Coed Sailor Awards
- 36 All-America Crew Awards
- 17 All-America Women's Awards
- 4 Collegiate Sailor of the Year
- Collegiate National Championships:
- Dinghy and Women's Champions six times each
- Team Racing and Sloop Champions six times each
- Singlehanded Champions Seven times
- Fowle Trophy - Best Overall Collegiate Team Performance
- Navy has won 10 times! More than any other university in the nation!
- Multiple Olympic Campaigns in the Laser, Finn, 470, 49er, & Soling Classes

Find more info about the Navy Sailing Programs by visiting our website:  
<http://www.usna.edu/SailingTeam/>

# NAVY SAILING FLEETS

## COLLEGIATE 420

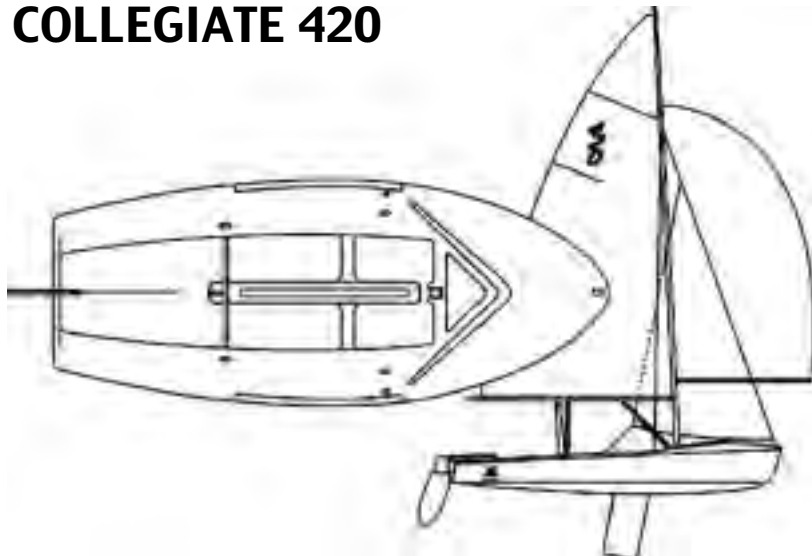

### SPECS

**LOA:** 13' 9"

**Beam:** 5' 5"

**Sail Area:** main and jib - 110 square feet

**Weight:** 260 pounds (fully rigged)

The Collegiate 420 was designed and built in response to the growing need for a more durable, high-performance, double-handed racing dinghy that could stand up to the rigors of club and collegiate programs. Ideal for crews ranging in size from 220-310 pounds.

### SPECS

**LOA:** 13' 10.5"

**Beam:** 4' 6"

**Sail Area:** 76 square feet

**Mast Height:** 20' 1"

**Hull Weight:** 130 pounds

**Designer:** Bruce Kirby

The Laser is designed for simplicity. The hull shape, blades and rig combine to create the ultimate sailing machine. Every Laser in the world is identical, and strict class rules ensure that every boat is identical. The Laser is a challenging boat that rewards athleticism, subtle steering and trimming techniques as well as tactical excellence.

## LASER

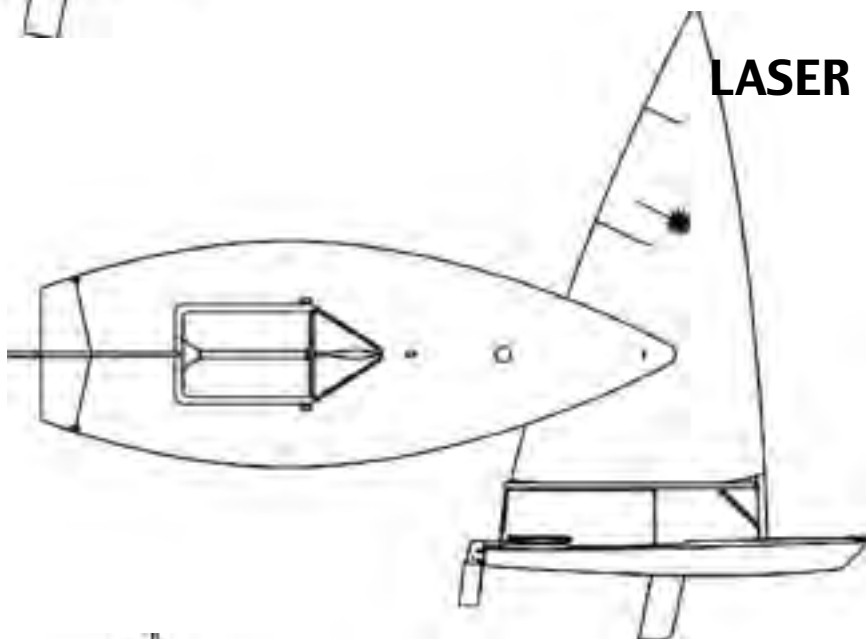

## COLLEGIATE FJ

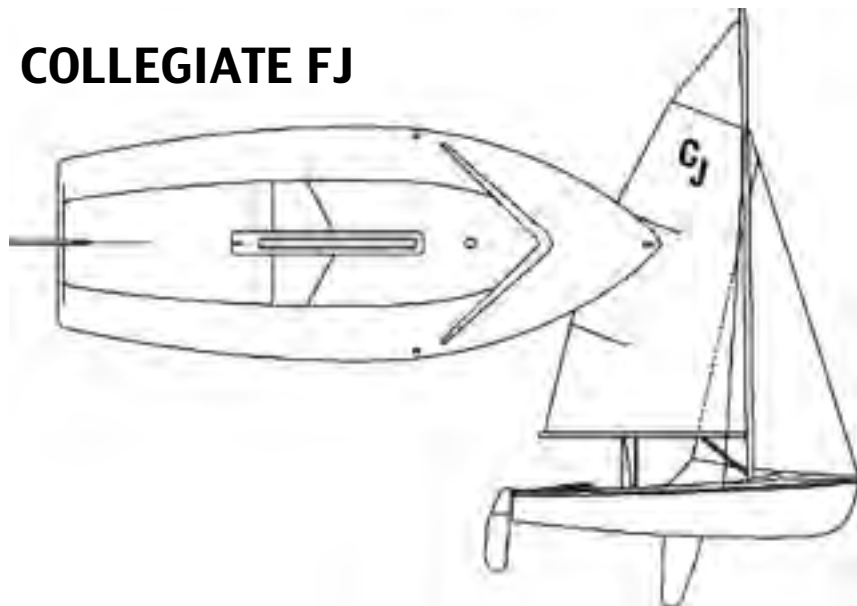

### SPECS

**LOA:** 13' 3"

**Beam:** 4' 11"

**Sail Area:** Main and jib @ 100 square feet

**Rigged Weight:** 255 pounds

The Collegiate FJ is sailed by more collegiate sailing teams than any other doublehanded sailboat. The simple layout serves as a fantastic teaching aid to high school and collegiate sailors as well. It requires sailors to become ultra sensitive to small changes in halyard tension, heel angle, mainsheet trim, and jib sheet trim. The Collegiate FJ deep rounded hull shape allows for easy maneuverability, which also encourages sailors to hone their boathandling skills. This ease in handling that the Collegiate FJ allows also makes it an excellent boat for team racing.

# INDIVIDUAL HONORS

## NAVY COLLEGIATE ALL-AMERICA SAILORS

Robert D. Fischl	1967
R. DuBose Joslin	1969
Daniel M. Rugg	1969, 1970
William L. Campbell	1971, 1972, 1973
Douglas W. Hart	1976
Paul A. LaBossiere	1977
Garland P. Wright	1977
Gerard T. Coleman	1978, 1979, 1980
Timothy J. McGee	1978
Paul M. Van Cleve	1978, 1979
Jasper Craig	1979, 1980
Robert K. Anoll	1980, 1981
John G. Speer	1980
Mary Brigden	1981
Nick Madigan	1981
Robert B. Brown	1983
Harold L. Gilreath, Jr.	1983, 1984
Brian Ledbetter	1983, 1984, 1985
Rick Merriman	1983, 1984, 1985
Robert E. Hallawell	1985, 1986, 1987
George Slook	1986
Alexander C. Cutler	1986, 1987, 1988
Edward A. Eckert	1987
Per Lovfald	1988, 1989
Keith B. Davids	1988, 1989, 1990
Charles Pucciariello	1989
Bradley M. Rodi	1990, 1991, 1992, 1993
William B. Graves	1991, 1992
Susan S. Minton	1991, 1992
Michael G. O'Bryan	1992, 1993
David G. Fagen, III	1993, 1994
Eric Naranjo	1994
Ryan Cox	1994, 1995
R.D. Burley	1995, 1996
William C. Stout	1996, 1997, 1998
Dean R. Balcirak	1997, 1998
Eugene Schmitt	1999
Travis Weber	2001, 2002

## NAVY COLLEGIATE ALL-AMERICA WOMEN'S SAILORS

(First Awarded In 1987)

Susan Mitchell	1987
Gretchen Stage	1987, 1988
Cynthia Williams	1989, 1991
Susie Minton	1989, 1990, 1991, 1992
Mallory Mestayer	1994, 1995, 1996, 1997
Julie Younger	1995, 1996, 1997, 1998

## HALL OF FAME

The College Sailing Hall of Fame recognizes sailing achievement prior to the establishment of All-America honors in 1967 and Women's All-America honors in 1987, or contribution to intercollegiate sailing. The following are those Naval Academy graduates that have been so honored and named to the Intercollegiate Hall of Fame:

1970	James P. Googe Jr. '57; Charles R. Ulmer '61
1971	David C. Minton III '56; Richard I. Tillman '58
1994	Kathryn Karlson '80
1995	Pamela Corwin '83; Deborah Dunbar '82
1998	Adm. Robert W. McNitt '38

## NAVY COLLEGIATE HONORABLE MENTION ALL-AMERICA SAILORS

Mary Brigden	1980
Mark Converse	1981, 1982
Debbie Dunbar	1981
Robbie Brown	1982
Ted Mortensen	1982
Dixon Smith	1982
Pam Corwin	1983
Scott Harrison	1985
George Slook	1985
Keith Davids	1987
Ted Williams	1987
Jay Cavaliere	1989
David Blackman	1990
Mike Varney	1990
Tim Wachendorfer	1991
David Fagen	1992
Ryan Cox	1993
Eric Naranjo	1993
Will Stout	1995
Walter H. Allman	1996, 1997
Grant Garcia	1999
Wade Tornyos	1999, 2000
Alexa Bestoso	2004

## NAVY SAILING ALL-AMERICA CREW

Cheri Kerr	1983, 1984
Melanie Kirby	1983
Allie Coetzee	1985
Emily Almonte	1986, 1987, 1988
Jamie Fontanella	1986
Yvette Gonzalez	1987, 1989
Sally Chamberlain	1988, 1989
Shane Baldino	1990, 1991
Julie Kohl	1990, 1991
Jeri Lea Smalley	1991
Jennifer Jones	1992
Reid McLaughlin	1992
Heather Keane	1993, 1994
W. Paul Kenney	1993
Akane Saunders	1993
Melissa Jackson	1994
Blanca Funes	1994, 1995
Jessica Danluck	1995, 1996, 1997
Erica Muesler	1995, 1996, 1997
(Won Robert H. Hobbs Sportsmanship Trophy)	
Susan Olivier	1998
Maria Alsina	1999
Missy Carter	2000
Emilia Spencer	2002

# OUTLOOK

The co-ed varsity offshore sailing team (VOST) practices daily during the fall and spring seasons in 12 J-24s, 10 Navy 44s and a variety of donated boats, with competitions on weekends in both intercollegiate and open races. During the summer, the VOST competes in offshore races along the East Coast, Bermuda, Halifax, Nova Scotia and occasionally on the Great Lakes as part of its summer programs training.

The J-24 fleet is used by the junior varsity team to train the less experienced freshman team members in sailing and racing techniques in preparation for their move to the offshore boats. It also provides an opportunity for sophomore team members to gain valuable leadership experience while serving as skippers during the fall. These skippers are selected from all the freshman members and have the opportunity to move into positions of responsibility when they move to the offshore boats. The junior varsity team competes in outside J-24 regattas, intercollegiate regattas and an intrasquad championship.

Typically, the VOST trains in a fleet of eight to 10 identical Navy 44s. A fleet of donated boats is utilized on some fall weekends and in the summer racing. Navy has the largest offshore training fleet in the United States and plays host to most of the intercollegiate sailing's big boat regattas.

Offshore sailing serves as the perfect platform for team building, leadership skills and seamanship training, including navigation, maintenance, weather and tactics. The Midshipmen sail the boats, do the planning and make the decisions. Many graduates of the team entered the Academy with no sailing experience, yet leave the team with self-confidence and respect for the sea, as well as skills that will carry forward in their naval careers that come from racing a boat hard in the open ocean.





# HEAD COACH JAHN TIHANSKY

## 1st Year at Navy

Jahn Tihansky enters his first year as the varsity offshore head coach after many successful years of racing and being on the water his entire life. He grew up sailing on Tampa Bay out of the Davis Island Yacht Club. His early days were spent knocking around on a home-built Optimist pram followed by a Sunfish and then a Laser. He began crewing on

MORC-sized boats at age 13 and within a few years was working summers in a sail loft and rigging shop. He became a full time sailmaker working first with Johnson Sails and then Hood Sails. In 1981, he bought the first of three J24s he has owned and campaigned it extensively throughout Florida, winning the district championships on multiple occasions and finishing 13th in his first Midwinter Championships in 1982. He continued actively sailing J24s through 1986, skippering at two World Championships and crewing at another. His position as a sail maker provided an entry into big-boat sailing and he competed in far-flung regattas such as Block Island Race Week, the MORC Internationals and his first of many SORCs in 1981.

In 1984, at age 22, he opened his own franchise of Sobstad Sails in Tampa, Fla., and spent most of his on-water time sailing with customers. In 1987, he married his wife, Patricia, and moved to Connecticut to work at the headquarters of Sobstad. While in New

England, he was part of the winning team at the 1987 J35 North Americans. The following year, he relocated to Annapolis doing a short stint as a yacht broker followed by four years working with Larry Leonard's Sobstad (now Quantum) Sails. Working for Leonard in Annapolis opened the door to grand prix big-boat sailing opportunities including the Corum Japan Cup, Kenwood Cup, Key West Race Week and 50-foot regattas with some of the world's top sailors.

In 1993, Jahn accepted the job as manager of the newly opened J World Sailing School franchise in Annapolis. Over the following winter, he acquired ownership of the company and has managed it up to the present. While running the school, Jahn developed numerous specialized training programs including regatta competition with students making up the crew in events such as Key West Race Week, Heineken Regatta in St. Martin, SORC, Chesapeake Bay's Screwpile Regatta and the Ft. Lauderdale to Key West Race. His teams often finished in the money and have won a few of these events.

More recently, he bought into a 505 which he and his partner have been racing fairly actively including the 2004 world championships in Santa Cruz, Calif.

Jahn holds a 50-ton Master Coast Guard license, is a US Sailing certified instructor/trainer and also has his FAA private pilot's license. He and his wife reside in the West River area just south of Annapolis.

## ASSISTANT COACH



### PETE CARRICO ASSISTANT COACH

Pete Carrico was named assistant coach of the offshore sailing team in the summer of 2000, although he has been involved with the Midshipmen program since the 1980's.

Carrico served as a Naval Station sailcraft rigger before being promoted to sailcraft operator in 1990, where he supervised the maintenance of the offshore sailing team fleet.

A lecturer on NAVY 44 rigging and NAVY 44 Mechanical Systems for the past eight years, Carrico also has 37 years of sailing experience with numerous grand-prix regattas and major offshore races as bowman, trimmer, watch captain and crew boss.

He also has served as the dinghy team member, captain and commodore at St. Mary's College, 1977-80.



# ROSTER

## VARSITY

Name	Yr.	Hometown/High School	Major
Gregory Blok	Jr.	Grandville, Mich./Grandville	Naval Architecture
Anthony Bracalente	Jr.	Margate, N.J./St. Augustin Prep	Ocean Engineering
Joseph Campbell	Jr.	Medina, Ohio/Fairview	EASA
Chris Canales	Sr.	Willis, Texas/Willis	Information Technology - National Security Affairs
John Casilio	Sr.	Hellertown, Pa./Allentown Central Catholic	Aerospace Engineering
Colin Chandler	Sr.	Lafayette, Calif./Campolindo	Political Science
Patrick Collins	Sr.	Elkhart, Ind./Elkhart Central	Systems Engineering
Thomas Deding	Jr.	Vermillion, S.D./Vermillion	EASA
Joe Dyckman	Sr.	Harrisburg, Pa./Central Dauphin	Aerospace Engineering
Christine Ellenburg	Sr.	Frisco, Texas/Frisco	Political Science
David Faherty	Sr.	Sparta, N.J./Pope John XXIII	History
Ryan Field	Jr.	Dana Point, Calif./Dana Hills	Political Science
Nicholas Goddard	Jr.	Melbourne, Fla./Eau Gallie	Political Science
Chris Hamilton	So.	Tampa, Fla./Tampa Jesuit	Political Science
John Hayes	So.	Plainsboro, N.J./West Windsor	English
Daniel Howard	Sr.	San Diego, Calif./Torrey Pines	Aerospace Engineering
Rebecca Islin	Jr.	Lincolnton, Maine/W.T. Woodson	ENA
Nick Kasatkin	Jr.	Brooklyn, N.Y./Stuyvesant	Mechanical Engineering
Ryan Kimmel	Jr.	Santa Rosa, Calif./Rincon Valley Christian	Information Technology - Macro Economics
James Lawsing	So.	Castine, Maine/George Stevens Academy	Political Science
Bret Leach	So.	Castine, Maine/George Stevens Academy	Systems Engineering
Leigh Loesel	Jr.	Erie, Pa./McDowell	Political Science
Richard Mayfield	Jr.	Laguna Hills, Calif./Laguna Hills	Systems Engineering
Ross Miller	Sr.	Okemos, Mich./Okemos	Information Technology
Monica Mondloch	Jr.	Waukesha, Wisc./Catholic Memorial	Aerospace Engineering
Chris Morales	Jr.	New York, N.Y./Loyola School	Political Science
Jaime Moreno	Jr.	Tampa, Fla./Armwood	Political Science
Gregory Nannig	Jr.	North Kingston, N.C./North Kingston	Naval Architecture
James Paquette	Sr.	Wausau, Wis./West	Aerospace Engineering
Jeff Parker	Sr.	Newbury Port, Mass./Northfield Mt. Herman	Quantitative Economics
Jesse Simmermon	So.	Schaefferstown, Pa./Eastern Lebanon County	Political Science
Evan Scott	Jr.	Grosse Pointe, Mich./Grosse Pointe	Naval Architecture
Reid Smythe	Jr.	Culver City, Calif./Culver City	Aerospace Engineering
Jared Spencer	Jr.	New Orleans, La./Marine Military Academy	Mechanical Engineering
Bonner Stave	Jr.	Delray Beach, Fla./American Heritage	Naval Architecture
Shawn Stolsig	So.	Seattle, Wash./Ballard	Computer Science
Greg Storer	Sr.	Branford, Conn./Branford	Ocean Engineering
Joshua Straume	Sr.	Santa Monica, Calif./Santa Monica	Naval Architecture
James Swiggart	Jr.	Darien, Conn./The Hill School	Political Science
Andrew Tabellion	Sr.	Severna Park, Md./Chesapeake	Aerospace Engineering
Wes Urquhart	Sr.	Manchester, N.H./Trinity	Systems Engineering
Dane Watson	Sr.	Indiano, Pa./Indiano	Aerospace Engineering
Jared Webster	Jr.	Adams, Tenn./Clarksville Academy	History
J Whorley	Jr.	Sheldon, Iowa/Sheldon Public	History

**\*\* Freshmen will not be known until later in the season.**

# SCHEDULE

## FALL 2005

Date	Event
Aug. 20-21	Past Commodore Ira G. Ross Great Race for the James H. Righter Trophy
<b>Sept. 3 - 5</b>	<b>Annapolis Race Week</b>
Sept. 17	NASS Race to Oxford
Sept. 18	Hammond Memorial Regatta
Oct. 1	AYC Fall Series #1
Oct. 2	AYC Fall Series #1
Oct. 8	Storm Trysail Offshore Intercollegiate Regatta
Oct. 8 - 9	AYC Fall Series #2
Oct. 9	AYC Fall Series #2
Oct. 15	AYC Fall Series #3
Oct. 16	AYC Fall Series #3
Oct. 22 - 23	MacMillan Cup
Oct. 27 - 30	US Sailing Offshore Championship for the Lloyd Phoenix Trophy
Oct. 29 - 30	IMS 50 Tred Avon Fall Finale
Nov. 4 - 6	IRC East Coast Championship
Nov. 4	J-24 East Coast Championship
Nov. 5 - 6	J-105 Fleet Championship
Nov. 5	J-22 Fleet Championship



# MIDSHIPMEN PROFILES



## CHRIS CANALES

SENIOR  
WILLIS, TEXAS

Canales began sailing the year before joining the Academy at the Naval Academy Prep School in Newport, R.I., where he perfected his trimming skills ... he currently acts as a skipper and helmsmen for the offshore team.

Personal: Graduated from Willis H.S. ... he ran track, cross country and pole vaulted while at Willis ... son of Juan and Mary Canales.



## JOSEPH DYCKMAN

SENIOR  
HARRISBURG, PA.

Had little sailing experience before coming to the Academy ... was a skipper on the JVOST team and went on to sail in the 2004 Newport to Bermuda Race as a trimmer on Lively which won first in class for that race ... was XO on NA-10 in the fall

and is currently training to be on Phoenix for the 2005 Block Island Race week.

Personal: Son of Dennis and Julia Dyckman.



## JOHN CASILIO

SENIOR  
HELLERTOWN, PA.

Has no prior sailing experience and serves as a bowmen on this year's team.

Personal: Graduated from Central Catholic H.S. in 2001 ... son of Frank and Sherri Casilio.



## DAVID FAHERTY

SENIOR  
SPARTA, N.J.

Has participated on the VOST as a bowman, mastman, strings and J-24 skipper ... was the navigator of Patriot in the Annapolis to Bermuda Race.

Personal: Graduated from Pope John XXIII High School ... Son of David and

Kathryn Faherty.



## COLIN CHANDLER

SENIOR  
LAFAYETTE, CALIF.

Serves as skipper and trimmer on the offshore team ... after spending a semester at Northwestern Prep School, he attended a semester of college in Santa Barbara, Calif., and hitched a ride on a J-105 while participating in the weekly Wednesday night spring

racing series.

Personal: Graduated from Campolindo H.S. ... son of Jim and Dianne Chandler.



## DANIEL HOWARD

SENIOR  
WHIDBEY ISLAND, WASH.

Since joining the VOST team, he has been a main trimmer, tractician and helmsman, as well as skipper of one of the smaller J24's ... he sailed FJ's on his high school's varsity team, eventually becoming team captain during his senior year.

Personal: Graduated from Torrey Pines High School ... son of CDR A.J and Connie Howard ... an aeronautical engineering major.



## PATRICK COLLINS

SENIOR  
ELKHART, IND.

Had no sailing experience prior to coming to Navy ... participated on the junior varsity team and in the 2004 Annapolis-Bermuda race as a bowman, then skippered NA-11 Swift during the fall season and NA-12 during the spring.

Personal: A systems engineering major ... son of Richard and Kathleen Collins.

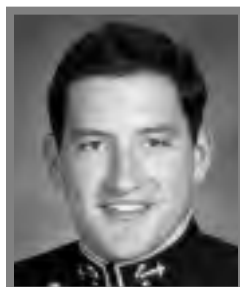

## ROSS MILLER

SENIOR  
OKEMOS, MICH.

Was the XO of Hellcat and the main trimmer for three years ... continues to contribute to the team and win races for the Mids ... sailed dinghys recreationally prior to attending Navy.

Personal: Graduated for Okemos High School ... son of James and Sue Miller ... majoring in information technology.



## JAMES PAQUETTE

**SENIOR**  
WAUSAU, WISC.

Started sailing during plebe summer and his first semester was spent on the J-24 team ... found himself on Navy 44's during the spring semester as a stringsman ... took over the bow the summer before his sophomore year and hasn't given it up since.

Personal: Graduated from Wausau West High School in 2002 ... son of Donald and Luann Paquette.

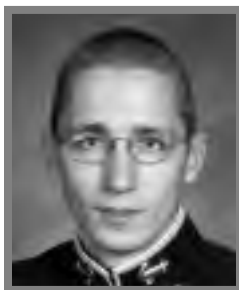

## ANDREW TABELLION

**SENIOR**  
SEVERNA PARK, MD.

Has no prior sailing experience before coming to the Academy ... is now mostly a mastman / trimmer, but may be seen elsewhere.

Personal: Graduated from Chesapeake High School ... son of Michael and Wanda Tebellion.



## JEFF PARKER

**SENIOR**  
NEWBURYPORT, MASS.

His past sailing experience includes working on the Spirit of Massachusetts, grinding on chartered cup boats Canada IV and Stars & Stripes and helping his family create their boats ... he was a watch captain while sailing transatlantic last summer of

board of the American Promise ... is currently the mainsail trimmer for the crew competing in the Kennedy Cup.

Personal: Graduated from Northfield Mt. Hermon Prep ... son of Jeff Parker Sr., and Dorothy Givner.



## GREGORY STORER

**CAPTAIN**  
**SENIOR**  
BRANFORD, CONN.

Storer has sailed dinghys for several years and transitioned to big boats when he came to the Academy ... he's been helmsman on Anthem, an ID35, as well as the winning McMillan Cup and Intrepid Cup teams ... he has also skippered Allegiance, a J/105 and boats that have competed in regattas in Larchmont, Buffalo, San Diego, France and Italy.

Personal: Son of Hap and Teresa Storer.



## JOSH STRAUME

**SENIOR**  
SANTA MONICA, CALIF.

Straume sailed on the intercollegiate team last season, helping the Mids to a second-place finish at the Nevins Trophy in October of 2003.

Personal: Attended Santa Monica High School ... Son of Kristina Straume ... born

Aug. 15, 1984 ... majoring in Naval Architecture.





**WES URQUHART**

**SENIOR  
MANCHESTER, N.H.**

Urquhart started his sailing career at the Naval Academy Preparatory School in Newport, R.I. ... participated on the junior varsity team, where he went on to become a skipper in the JVOST program ... then moved on to become the trimmer in a successful season on the J-10 Allegiance ... currently the trimmer on the newly donated "Hellcat".

Personal: Graduated from Trinity High School in Londonderry N.H. ... son of Glenn and Cathy Urquhart



**DANE WATSON**

**SENIOR  
INDIANA, PA.**

With no prior racing experience, Dane joined the junior varsity team during his plebe year and moved to the varsity team the next year ... he was placed on the bow, rotating between bowman, strings and mast ... during his summers, he has performed in the Newport-Bermuda Race, CSNTS trip to New London, Conn. and Block Race Island Race Week.

Personal: Graduated from Indiana Area High School ... son of David and Denise Watson.



**GREGORY BLOK**

**JUNIOR  
GRANDVILLE, MICH.**

Had no formal racing experience, prior to arriving at the Academy ... did sail on lakes growing up.

Personal: Graduated from Grandville High School ... a Naval Architecture major.



**ANTHONY BRACALENTE**

**JUNIOR  
MARGATE, N.J.**

Served as bowman / main of XO and AP2 ... spent a year doing bow and a semester performing main ... his ultimate goal is to skipper a donated boat ... sailed on USCGC

Barque Eagle and competed in the Boston to Halifax race.

Personal: Graduated from St. Augustine Prep ... son of Robert Bracalente ... majoring in ocean engineering.

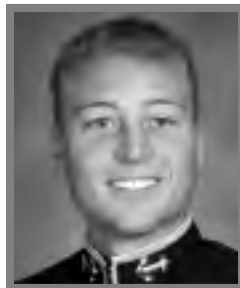

**JOSEPH CAMPBELL**

**JUNIOR  
MEDINA, OHIO**

Had no formal racing / sailing experience, prior to arriving at the Academy ... became the skipper of American Promise and his goal is to win the Marion / Bermuda race for the Mids.

Personal: Graduated from Medina High School ... son of Greg and Janet Markus ... an EASA major.

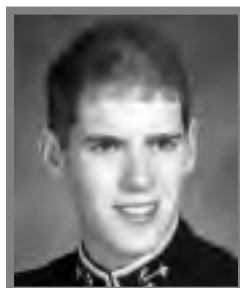

**THOMAS DEDINGER**

**JUNIOR  
VERMILLION, S.D.**

Served on the bow crew for one year and his goal is to become a skipper ... was a sailing instructor at Boy Scout Camp, and enjoyed cruising on his family sailboat.

Personal: Graduated from Vermillion High School ... son of Bill and Cyndi Deding ... an EASA major.



**RYAN FIELD**

**JUNIOR  
DANA POINT, CALIF.**

Started his freshman year on J-24's, and has been a helmsman and trimmer ... aims to be a helmsman in the future ... competed in several races around southern California.

Personal: Graduated from Dana Hills High School ... son of Philip and Linda Field ... a political science major.



**NICHOLAS GODDARD**

**JUNIOR  
MELBOURNE, FLA.**

Had no formal sailing experience prior to arriving at the Academy ... served as trimmer for one year and aims to become a skipper by the time he graduates

Personal: Graduated from Eau Gallie High School ... son of George and Theresa Goddard ... a political science major.



**REBECCA ISLIN**

**JUNIOR  
LINCOLNVILLE, MAINE**

Served as XO on NA-12 for the summer ... was a trimmer before receiving summer boat assignments ... began her Navy career by trimming on JVOST and later skippered on the JVOST team ... goal is to trim main, drive and / or skipper ... learned to sail

on a MiniFish ... began sailing big boats in Newport, R.I., and joined the Pentagon Sailing Club in 2000, where she became a sailing instructor and began to work on her D-Qual.

Personal: Graduated from W.T.Woodson High School ... daughter of Nick and Cynthia Islin ... an ENA major.



**NICK KASATKIN**

**JUNIOR  
BROOKLYN, N.Y.**

Served as bowman, strings and mastman since last summer ... hopes to perform bow on Phoenix ... had no formal sailing experience prior to the Academy.

Personal: Graduated from Stuyvesant H.S. ... son of Dmitriy and Sofie Kasatkin ... a mechanical engineering major.



**RYAN KIMMEL**

**JUNIOR  
SANTA ROSA, CALIF.**

Served as bowman on Hellcat for one semester ... had no prior sailing experience before arriving at the Academy.

Personal: Graduated from Rincon Valley Christian School ... son of Gary and Gay Kimmel ... an information technology, macro-

economics major.



**LEIGH LOESEL**

**JUNIOR  
ERIE, PA.**

Had a solid sophomore season, serving as the tactician onboard Javelin in the fall of 2004 and as the tactician onboard the Kennedy Cup boat in the spring ... goal is to lead Navy to victories in the Kennedy Cup and Newport / Bermuda Ocean Race ...

sailed lasers, 420s and keelboats on Lake Erie growing up.

Personal: Graduated from McDowell High School ... son of David and Michelle Loesel ... majoring in political science.



**RICHARD  
MAYFIELD**

**JUNIOR  
LAGUNA HILLS, CALIF.**

Served as a bowman during the past season and as an XO during the summer ... hopes to become a skipper soon ... had no prior sailing experience before arriving at the

Academy.

Personal: Graduated from Laguna Hills High School ... son of Bob and Leigh Ann Mayfield ... a systems engineering major.



**MONICA  
MONDLOCH**

**JUNIOR  
WAUKESHA, WISC.**

Served as a stringman since summer of 2004 ... intends to get her D-Qual this fall ... aims to crew on a donated boat in the fall and eventually be a skipper ... sailed on family's 25-foot catalina on Lake Michigan until age eight, when she began dinghy racing in optimists, lasers and X-scows ... worked as an optimist instructor with racers aged 4-12.

Personal: Graduated from Catholic Memorial High School ... daughter of Mike and Vicki Mondloch ... an aerospace engineering major.



**CHRIS MORALES**

**JUNIOR  
NEW YORK, N.Y.**

No prior sailing experience before arriving at the Academy.

Personal: Graduated from Loyola H.S. ... a political science major.

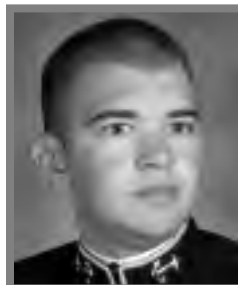

**JAIME MORENO**

**JUNIOR  
TAMPA, FLA.**

Has served as a bowman for two years ... had no prior sailing experience before arriving at the Academy.

Personal: Graduated from Armwood High School ... son of Jose Moreno and Cecilia Munera ... a political science major.

## 2005-06 NAVY OFFSHORE SAILING



### **GREGORY NANNIG**

**JUNIOR**  
**NORTH KINGSTOWN, R.I.**

Served as a main trimmer in 2004-05 ... spent 10 years sailing on Narragansett Bay and was a member of the North Kingstown High School sailing team.

Personal: Graduated from North Kingstown High School ... son of Douglas and Ellie Nannig ... a naval architecture major.

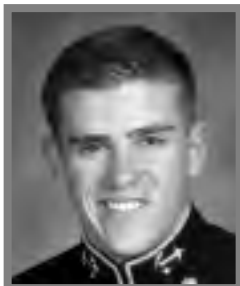

### **EVAN SCOTT**

**JUNIOR**  
**GROSSE POINTE, MICH.**

Grew up sailing tartan-10's doing bow, then transitioned to positions on other boats ... also sailed J-105's, Carrera 290, FJ's, 420's, X-402 among others ... raced with Grosse Pointe South High School team, advancing to Mallory Nationals.

Personal: Graduated from Grosse Pointe South High School. ... a naval architecture major.



### **REID SMYTHE**

**JUNIOR**  
**CULVER CITY, CALIF.**

Currently a crewman, but aims to be a skipper soon ... had no prior sailing experience before arriving at the Academy.

Personal: Graduated from Culver City High School ... son of William Smythe and Christina Roese ... an AERO major.

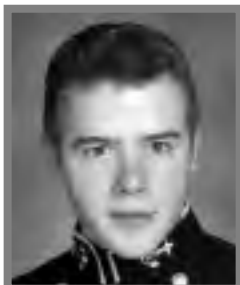

### **JARED SPENCER**

**JUNIOR**  
**NEW ORLEANS, LA.**

Served as jib and spin trimmer ... hopes to be a skipper in the near-future ... sailed lasers and 420's at Southern Yacht Club before arriving at the Academy.

Personal: Graduated from the Marine Military Academy ... son of L. Clay and Stephanie Spencer ... a mechanical engineering major.



### **BONNER STAVE**

**JUNIOR**  
**DELRAY BEACH, FLA.**

Spent his first season on the VOST team and was a mastman on the Javelin crew during the fall ... was a stringsman on the Hellcat during the spring and summer training ... aspires to be a member of a championship crew in competition with professional sailors

... participated in the Key West summer sailing program and lived on a boat for nine years.

Personal: Graduated from the American Heritage School ... son of Bob and Pam Stave ... a naval architecture major.

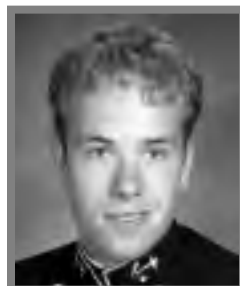

### **JAMES SWIGGART**

**JUNIOR**  
**DARIEN, CONN.**

Served as a tactician, navigator and bowman since 2004 ... raced extensively in the Junior Sailing Association of Long Island Sound from ages 8 to 18 ... participated in Y.R.A.L.I.S., PHRF, one-design and offshore racing in the Northwest.

Personal: Graduated from the Hill School ... son of Carolyn J. Swiggart ... a political science major.

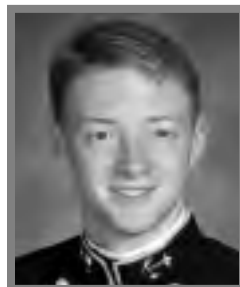

### **JARED WEBSTER**

**JUNIOR**  
**ADAMS, TENN.**

Had no sailing experience prior to arriving at the Academy.

Personal: Graduated from Clarksville Academy ... a history major.

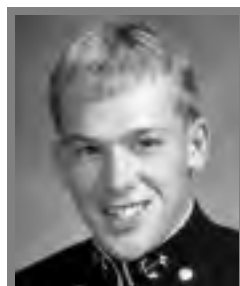

### **J WHORLEY**

**JUNIOR**  
**SHELDON, IOWA**

Goal is to become a strong helmsman and a skipper ... had no sailing experience prior to arriving at the Academy.

Personal: Graduated from Sheldon High School ... son of Thomas and Janna Whorley ... a history major.

# NAVY 44'

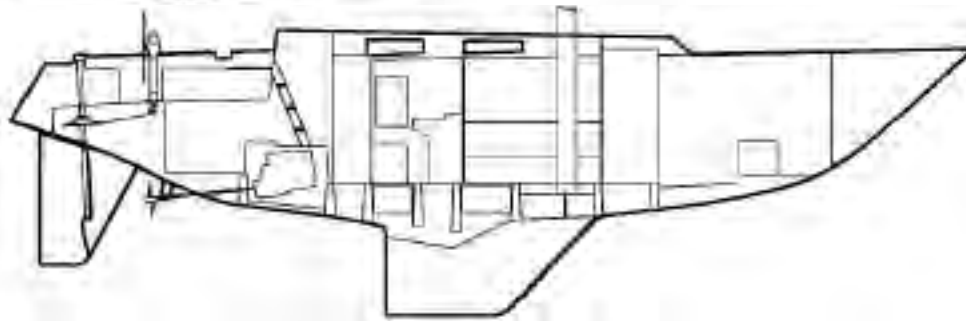
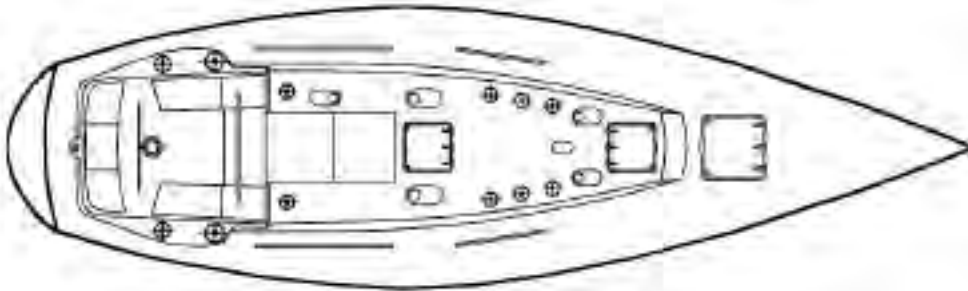

**SPECS**

**LOA:** 44'  
**Beam:** 12'5"  
**Sail Area:** 956 square feet  
**Draft:** 7'3"  
**Weight:** 28,000 pounds  
**Designer:** McCurdy & Rhodes

## AWARDS AND HONORS

### KENNEDY CUP

The John F. Kennedy Memorial Trophy was presented to the U.S. Naval Academy in 1965 on behalf of the many friends of the late President. President Kennedy's love for sailing is perpetuated in the annual competition for the trophy, which represents the National Collegiate Large Yacht Championship.

1966	.....	.Robert L. Hamilton, Jr.
1977	.....	.Richard O'Sullivan
1980	.....	.Nick Madigan
1981	.....	.Nick Madigan
1982	.....	.Dixon Smith
1988	.....	.Dan Whitney
1989	.....	.Charles Pucciariello
1990	.....	.Kevin Hawko
1993	.....	.Oliver Vietor
1995	.....	.Stephen Karson
1997	.....	.Ryan McCrillis

### MCMILLAN CUP

College sailing's oldest regatta was first competed for in 1928 and hosted at various sailing centers in New England. Since 1950 it has been hosted by the Naval Academy in its 44' sailboats and serves as the big boat championship for the New England and Mid-Atlantic districts.

1955	.....	.George Atkins
1958	.....	.Gene J. Porter
1961	.....	.Charles Ulmer
1977	.....	.Bruce Reichert
1980	.....	.Nick Madigan
1981	.....	.Dixon Smith
1984	.....	.Brain Ledbetter
1985	.....	.Thomas Luscher
1996	.....	.Mark Franko
1997	.....	.Matthew Morton
1999	.....	.Brian Solomon
2004	.....	.Tom Bock

### MAJOR OCEAN RACE VICTORIES

1992	Newport to Bermuda Race	.....	.Kyle Weaver
1993	Annapolis to Newport Race	.....	.Ara Barton
1994	Annapolis to Bermuda Race	.....	.Chris Fisher
1998	Around Long Island Race	.....	.Todd Greene
1999	Marion to Bermuda Race (celestial)	.....	.Jack Benfield
1999	Marion to Bermuda Race (team trophy)	.....	.Benfield, Almeida, Kellogg
2003	Block Island Race Week PHRF	.....	.Chad Ingle, Brooke Anderson

### NAVY OFFSHORE SAILING FLEET

<b>Colgate 26'</b>	.....	.26
<b>Navy 44's</b>	.....	.20
<b>J-24</b>	.....	.15
<b>Offshore boats</b>	.....	.6 (donated)
J-105	.....	.Allegiance
One-design 35'	.....	.Anthem
Farr-39ML	.....	.Hornet
Farr-43'	.....	.Blue Angel
C&C-48'	.....	.Patriot
Hood-60'	.....	.American Promise
<b>J-22</b>	.....	.1
<b>Sonar</b>	.....	.1

# UNITED STATES NAVAL ACADEMY

Secretary of the Navy George Bancroft laid the foundation for the Naval Academy when, in 1845, he established the Naval School at Fort Severn in Annapolis. Commander Franklin Buchanan served as the first Superintendent. His faculty consisted of four officers and three civilian professors. There were 50 students. Initially, the academic and professional instruction required five years—the first and last at Annapolis, with the intervening three at sea.

In 1850, the Naval School became the United States Naval Academy. The following year, the Academy adopted its current course of instruction which includes four consecutive years at Annapolis, with at-sea training provided during the summers.

The Naval Academy moved to Newport, R.I., during the Civil War. In 1865, it was re-established at Annapolis under the leadership of Vice Admiral David Dixon Porter. During these early years, the Academy was one of the few institutions of higher learning offering a sophisticated undergraduate course in technical education.

The late 19th century saw immense changes in naval technology with the conversion from sail-powered, wooden ships to steam-powered vessels of steel, which also resulted in rapid developments in naval weaponry and tactics. With the Spanish-American War in 1898, the United States became a world naval power, and early Naval Academy graduates like George Dewey and Alfred Thayer Mahan made significant contributions to our national heritage.

The new century saw the nation's undergraduate naval college grow in size and academic prowess. The Class of 1895 had produced 41 graduates. By World War I, there were nearly 200 graduates each year, along with 2,500 reserve officers who received their training at the Academy.

With the entry of the United States into World War I, courses were shortened to three years, a program which remained in effect

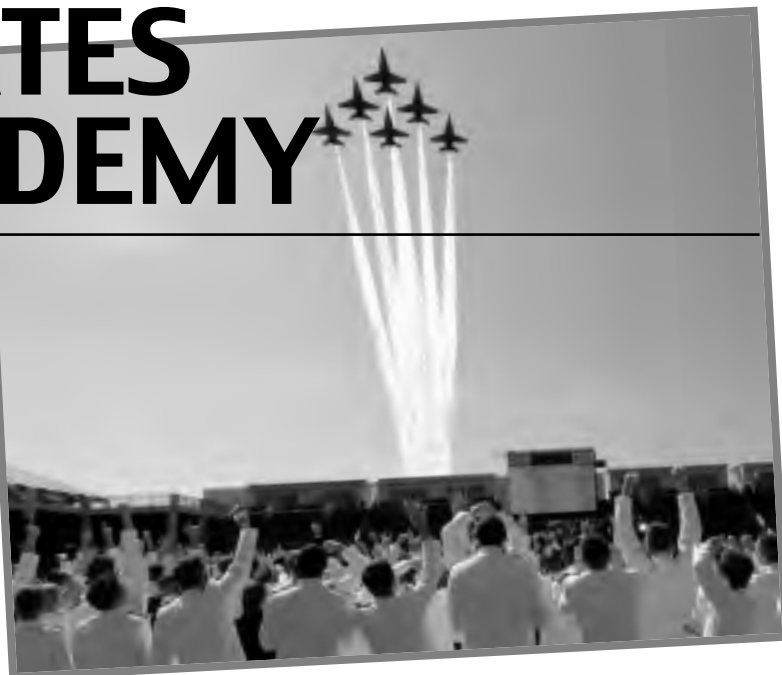

until 1921.

Between the two world wars, the curriculum and training equipment were modernized to keep pace with rapid advances in the naval profession and American education. In 1930, the Association of American Universities accredited the Naval Academy, and in 1933, an act of Congress authorized the Naval Academy to confer the degree of bachelor of science on graduates, beginning with the Class of 1931. Congress authorized award of the degree to all living graduates in 1939. The Middle Atlantic States Association of Colleges and Secondary Schools first accredited the Academy in 1947.

During World War II, summer sessions were instituted and the course was again shortened to three years. As during World War I, reserve officers, along with reserve midshipmen, also trained at the Academy.

In 1963, the Academy initiated the Trident Scholar Program, under which a number of exceptional students are permitted to pursue independent research during the first class (senior) year.

The 1964-65 academic year saw the civilian positions of academic dean and dean of admissions established and far-reaching changes made to the curriculum. The number of required core courses was reduced and, for the first time, each midshipman was allowed to pursue academic areas of individual interest for minor or major. Additional changes, introduced in the 1969-70 academic year, now require every midshipman to complete a major.

In 1975, President Gerald R. Ford signed legislation authorizing admission of women to the service academies. The first women midshipmen entered the Academy in July 1976 and graduated with the Class of 1980.

## MIDSHIPMEN LIFE

It all begins with fourth class year. From their first day at the Academy, the fourth class midshipmen, or plebes, undergo an intensive and unabated program of military training and indoctrination. Physical and mental demands on them and their time seem never-ending. But it all has a purpose: the development of leadership ability, motivation, moral strength, physical skills and stamina.

Plebe Summer is a time which most midshipmen will remember for many years. New midshipmen are kept constantly busy learning basic skills in seamanship, navigation and marksmanship. Their pride and company spirit are boosted through infantry drill, small arms train-

## NAVAL ACADEMY LEADERSHIP



**VICE ADM.  
RODNEY P. REMPT,  
USN  
Superintendent**



**CAPT. BRUCE GROOMS,  
USN  
Commandant of  
Midshipmen**

## MISSION OF THE NAVAL ACADEMY

**TO DEVELOP MIDSHIPMEN MORALLY, MENTALLY AND PHYSICALLY AND TO IMBUE THEM WITH THE HIGHEST IDEALS OF DUTY, HONOR AND LOYALTY IN ORDER TO PROVIDE GRADUATES WHO ARE DEDICATED TO A CAREER OF NAVAL SERVICE AND HAVE POTENTIAL FOR FUTURE DEVELOPMENT IN MIND AND CHARACTER TO ASSUME THE HIGHEST RESPONSIBILITIES OF COMMAND, CITIZENSHIP AND GOVERNMENT.**

ing, sailing Navy yawls and cruising in yard patrol craft. Their competitive spirit and desire to win are developed in activities such as athletics, dress parades and seamanship.

Plebe Summer is highlighted in August during Parents' Weekend, when parents visit the Academy and witness the progress of their sons and daughters.

The arrival of the upperclassmen in mid-August heralds the beginning of the academic year. The plebes embark on a four-year course of study while plebe indoctrination continues.

September brings the excitement of football and other fall sports. During the football season, only selected units of the brigade travel to away games, but the entire brigade attends all home games and the annual fall classic, the Army-Navy game.

Commissioning Week, in May, brings the graduation of the first classmen and the end of plebe year. Plebes signify the end of the first year at the Academy by scaling the smooth granite sides of Herndon Monument to replace, at its summit, a plebe cap with an upperclass cover.

Between plebe and third class years, midshipmen get their first taste of life at sea and their introduction to the enlisted men whom they will lead when commissioned as officers. Joining ships around the world, midshipmen perform a host of shipboard duties including standing deck, gunnery, operations and engineering watches. Midshipmen also have their first opportunity to visit foreign countries and experience different cultures.

Third classmen begin work in their academic majors and assume more responsibility in the military regimen at the Academy. Less emphasis is placed on indoctrination, leaving more time for studies, sports and extracurricular activities. It's a welcome change from the rigors of plebe year.

During their third summer, midshipmen get their first training in four warfare specialties which comprise the naval service. They learn about submarines at New London, Conn.; surface warfare at Norfolk, Va.; naval aviation at Pensacola, Fla.; and the Marine Corps at Quantico, Va.

Second class midshipmen are assigned still additional military responsibilities. They are selected and trained to direct the Brigade of Midshipmen during absences of the first class. They are also assigned an important role in indoctrination of the new plebe class, which develops their leadership skills. In academics, the second class midshipmen enter increasingly advanced areas of study.

During their final year at the Academy, first class midshipmen

complete the core curriculum and their academic majors' course requirements. Many undertake independent research projects, and some begin graduate-level studies at nearby universities. The first class midshipmen also take over the responsibilities for plebe indoctrination. They also lead the brigade at parades, formal ceremonies and daily formations. They are responsible for the conduct, military smartness and competitive records of their units. The skills which the first class midshipmen develop this year will help them when they assume their leadership responsibilities in the Navy and Marine Corps following graduation.

One common denominator which binds the four years into a unit which will forever shape the life of an Academy graduate is the Honor Concept.

Established and administered by midshipmen, the Honor Concept is based on the principle that honorable individuals do not lie, cheat or steal. All midshipmen are expected to conduct their lives in accordance with the Honor Concept so that their decisions as midshipmen, naval officers and civilians reflect the highest levels of honorable conduct.

## THE CURRICULUM

With the aid of academic and military advisors, midshipmen design their own blend of the curriculum's three elements:

- Courses providing the professional and leadership skills required in the naval service.
- "Core" requirements in engineering, social sciences, natural sciences and the humanities to ensure breadth in education.
- Completion of a major program in an academic subject chosen by each midshipman to develop individual interests and talents in depth.

The Naval Academy offers major programs in 19 subject areas: eight in engineering; seven in sciences and mathematics, including computer science, as well as information technology, the most recent addition; and four in the humanities and social sciences. Seven of the engineering majors are accredited professionally by the Engineering Accreditation Commission of the Accreditation Board of Engineering and Technology.

Selected humanities and social science majors with excellent records are invited to enter the rigorous honors programs offered by the departments of Economics, English, History and Political Science.



Outstanding students also have the opportunity to engage in independent study and research during their senior year. Those selected as Trident Scholars carry a reduced formal course load so they can pursue a major research project and prepare a thesis. They are assisted by one or more faculty advisors who specialize in the field of study.

A number of first class midshipmen who complete academic requirements early are encouraged to enroll in graduate classes at area universities. This Voluntary Graduate Education Program gives them the chance to graduate and receive commissions with their classmates, finish their graduate studies locally and then go to their first assignments with a master's degree.

All midshipmen undertake professional military training, beginning on the first day of Plebe Summer and continuing through first class year. This includes classroom studies, drills and practical training at the Naval Academy and with Navy and Marine Corps units during summer programs. Navigation, seamanship, tactics, naval engineering, weapons, leadership and military law are among the areas studied. To advance and graduate, midshipmen must pass professional competency examinations covering general knowledge and subjects related to their service selection.

The Naval Academy's physical education program complements academic and professional development of midshipmen. Instruction and training aim to develop individual skills and competitive spirit, life-long habits of physical fitness, and the capability to withstand physical hardship when necessary. All midshipmen must complete the four-year program which includes the Physical Readiness Test (twice annually), water survival, physical development, personal defense and lifetime carryover sports. Women participate in the same curriculum, including boxing, wrestling and judo.

## COMMISSIONING WEEK

Six days of parades, athletic events, colorful ceremonies, formal dances and receptions bring to a climax four years of challenging education and training.

One highlight of Commissioning Week is Color Parade. Each year, intra-brigade competition is conducted to determine which of the 30 companies stands highest overall on the basis of academics, intramural sports, professional drills and parade performance. During the parade, the color girl, who is selected by the Color Company commander, transfer the flags from the past Color Company to the new one.

The biggest social event of Commissioning Week is the ring dance for the second class midshipmen. An elegant formal affair, it is at this event that the midshipmen begin wearing their class rings.

First class midshipmen and their families attend the superintendent's garden party and reception, plus other social events. Athletic, academic and professional awards are presented in Alumni Hall. The evening before graduation, everyone is invited to attend the farewell ball.

On graduation day, friends and relatives gather with the midshipmen at Navy-Marine Corps Memorial Stadium. After the diplomas are presented and the oath of office is administered, the senior midshipman of the new first class leads three cheers for "those about to leave us." The graduates, led by the class president, reply with three cheers for "those we leave behind." On the last hooray of this cheer, the 1,000 graduates toss their midshipmen covers into the air. According to tradition, the honor of putting on the new Navy Ensign and Marine Corps Second Lieutenant shoulder devices is shared by mothers and Commissioning Week dates.

## NAVY BLUE & GOLD

**NOW, COLLEGES FROM SEA TO SEA  
MAY SING OF COLORS TRUE;  
BUT WHO HAS BETTER RIGHT THAN WE  
TO HOIST A SYMBOL HUE?  
FOR SAILORS BRAVE IN BATTLE FAIR,  
SINCE FIGHTING DAYS OF OLD,  
HAVE PROVED THE SAILOR'S RIGHT TO WEAR  
THE NAVY BLUE AND GOLD**

**FOUR YEARS TOGETHER BY THE BAY,  
WHERE SEVERN JOINS THE TIDE,  
THEN BY THE SERVICE CALLED AWAY  
WE'RE SCATTERED FAR AND WIDE;  
BUT STILL WHEN TWO OR THREE SHALL MEET  
AND OLD TALES BE RETOLD  
FROM LOW TO HIGHEST IN THE FLEET  
WE'LL PLEDGE THE BLUE AND GOLD.**



# NAVAL ACADEMY FACTS

## ALUMNI HALL

This \$30 million facility is used for concerts, lectures, plays, convocations, men's and women's basketball and other athletic events. It includes a reception area and dining room. The arena seats 5,710 fans for basketball contests.

## ANCHORS AWEIGH

"Anchors Aweigh" was written by Lt. Charles Zimmermann, Musical Director of the Naval Academy in 1906, with the lyrics provided by Alfred H. Miles of the Class of 1906, as a fight song for the 1907 graduating class instead of the usual class march Zimmermann had composed for previous classes. The song made its debut at the 1906 Army-Navy game, and when the Midshipmen won the game, the song became traditional at this game. It gained national exposure in the 1920s and 1930s when it was heard on the radio and was in a number of popular movies. In 1997 a one-hour documentary on the history of Navy football, titled "Anchors Aweigh for Honor and Glory", was produced by NFL Films. The film was deemed a success by both critics and fans alike.

## ANNAPOLIS

The capital of Maryland, Annapolis is the home of the Naval Academy. Annapolis is located 30 miles east of Washington, D.C. and 25 miles south of Baltimore.

## BANCROFT HALL

Named after former Secretary of the Navy George Bancroft, the Hall is home for the entire Brigade of Midshipmen. It contains 1,873 midshipmen rooms, nearly five miles of corridors and about 33 acres of floor space, making it one of the largest single dormitories in the world. All of the basic facilities midshipmen need for daily living, and many for recreation, are found in the Hall.

## BAND

The Navy's oldest continuing musical organization, the Naval Academy Band was formed in 1852 with 13 musicians. Now numbering 63 members, the band includes the wind ensembles, rock band, big band, woodwind and brass quintets, tuba and trombone quartets and the percussion ensemble. The band provides musical support to the Brigade of Midshipmen in parades and performances, and entertains members of the Academy family and civilian community throughout the year.



*Bancroft Hall*

## BILL THE GOAT

The first recorded use of a goat mascot for Navy athletic teams was in 1893 when an animal named El Cid (The Chief) was turned over to the Brigade by young officers of the USS New York. El Cid helped Navy to a 6-4 triumph over Army that year. Two cats, a dog, and a carrier pigeon have also enjoyed brief reigns as the Navy mascot, but goats have served without interruption since 1904.

Bill XXXI and XXXII are the current mascots. They are taken care of by 15 goathandlers made up of five midshipmen from the first, second and third classes. The goathandlers undergo rigorous training prior to handling Bill on the field.

## CO-ED

For many years, the Naval Academy was a male-only institution. But that changed when women were admitted in 1976. Today, 15 percent of the 4,000-member Brigade are women.

## DISTINGUISHED GRADUATES

- \* 1 President of the United States
- \* 2 Cabinet Members
- \* 1 Member of the Board of Governors of the Federal Reserve System
- \* 6 Ambassadors
- \* 19 Members of Congress
- \* 5 State governors
- \* 5 Secretaries of the Navy
- \* 1 Secretary of the Air Force
- \* 3 Chairmen of the Joint Chiefs of Staff
- \* 3 Vice Chairmen of the Joint Chiefs of Staff
- \* 25 Chiefs of Naval Operations
  - \* 9 Commandants of the Marine Corps
  - \* 73 Medal of Honor winners
  - \* 2 Nobel Prize winners
  - \* 52 Astronauts
  - \* 39 Rhodes Scholars
  - \* 15 Marshall Scholars
  - \* 84 Olmsted Scholars
  - \* 23 Fitzgerald Scholars
  - \* 766 Burke Scholars

## ENTERPRISE BELL

From the bridge of the famed World War II aircraft carrier, it has been a part of the Naval Academy tradition since 1950. The late Admiral Harry W. Hill, then Superintendent, was instrumental in bringing the "E" Bell to Annapolis. It rings when the Academy observes Morning Colors and also during special ceremonies when Navy scores a majority of victories over Army in any one of the three sports seasons. The bell also rings during Commissioning Week for those teams that beat Army and have not participated in a previous bell-ringing during the academic year. The bell is stationed in front of Bancroft Hall.

## FLAG RANK

The term used for reaching the rank of Admiral or General, these nine former Navy football captains have earned that honor: Vice Admiral Edward E. Ewen, USN (captain of the 1919 and 1920 teams), Rear Admiral Magruder H. Tuttle, USN (1931), Rear Admiral James Reedy, USN (1932), Lt. General Louis B. Robertshaw, USMC (1935), Brigadier General Rivers Morrell, USMC (1936), Major General Phil Monahan, USMC (1954), Major General John Hopkins, USMC (1955), Rear Admiral Thomas C. Lynch, USN (1963) and Rear Admiral Rick Porterfield, USN (1972).

## GOKOKUJI BELL

The bell is an exact replica of the 1456 casting brought to this country by Commodore Matthew C. Perry following his expedition to Japan in 1854. The original bell, donated to the Naval Academy by Commodore Perry's widow, was returned by the Navy to the people of Okinawa in 1987. Like the original bell, the replica is rung to celebrate football victories over Army. The bell is stationed in front of Bancroft Hall.



*The Gokokuji Bell is an exact replica of the 1456 casting brought to this country by Commodore Matthew C. Perry following his expedition to Japan in 1854. Like the original bell, the replica is rung to celebrate football victories over Army.*

## HUBBARD HALL

Also known as the Boat House, Hubbard Hall, which is located on Dorsey Creek, was the first Academy building to be named in honor of a living man. Rear Admiral John Hubbard, Class of 1870, stroke on the crew at that time. Hubbard Hall underwent major renovations in 1993 and now includes the Fisher Rowing Center, a state-of-the-art facility for Navy's extensive crew program.

## JOHNS HOPKINS UNIVERSITY

In 1883, Navy lost to Johns Hopkins University, 2-0, marking the Mids' first intercollegiate football game.

## MIDSHIPMAN

The word midshipman first appeared in English in the 17th century in the form of the word midshipsman to designate those men who were stationed "amidships," i.e. in the waist or middle portion of the vessel, while on duty. By 1687, however, the second 's' had been dropped to give the current form of the word. Midshipmen were originally boys, sometimes as young as seven or eight, who were apprenticed to sea captains to learn the sailor's trade.

In the early days of the American Navy, midshipmen trained aboard ship until they were eventually commissioned as ensigns. With the founding of the Naval Academy in 1845, it became possible, as it still is, for a midshipman to enter the Navy directly from civilian life. The name of students at the Naval Academy changed several times between 1870 and 1902, when Congress restored the original title of Midshipman, and it has remained unchanged since.

## NICKNAME

Navy's sports teams are referred to as the Midshipmen or Mids. The term "Middie" is inappropriate.

## NOTRE DAME

The Irish and Mids have played every year since 1927, in the longest continuous intersectional rivalry in college football today. Along with their academic philosophies, the two institutions have another bond – former Naval Academy Superintendent Rear Admiral Thomas C. Lynch, captain of the 1963 Navy football team, is the brother of 1966 Notre Dame football captain Jim Lynch.

## N-STAR

Members of varsity teams who qualify for their varsity letter receive an N-Star if they participate in a victory over Army in any sport designated "Star" competition.

## REEVES, JOSEPH M.

The first known football helmet was worn by Joseph M. Reeves in 1894. Legend has it "he wore a moleskin cap fashioned by a well-known lady of Annapolis."

## SCHOOL COLORS

Navy adopted Navy Blue and Gold as its colors back in 1892. At that time, each class at the Naval Academy had class colors. The Class of 1890 first used Navy Blue and Gold. In 1892, the minutes from the Naval Academy Auxiliary Athletic Association meeting reported, "The Committee reported favorable results of a conference with Naval Cadets as to the probability of adoption of Navy Blue and Gold as Academy colors."



*Jack Stephens Field*

## VARSITY ATHLETICS

In keeping with the mission of the Naval Academy, 30 varsity sports — 21 for men and nine for women — are offered for midshipmen.

## VICTORIES

With 599 all-time wins, Navy is 28th among Division I-A schools. Navy's all-time football record is 599-498-57, for a winning percentage of .544.

## THE YARD

The Yard, as the Naval Academy campus is called, features tree-lined brick walks, French Renaissance and contemporary architecture and scenic vistas of the Chesapeake Bay. The Bancroft Hall dormitory complex, the Cathedral of the Navy and other 82-year-old buildings make the Academy a National Historic Site.

## SHUTOUTS

Navy has recorded 265 of them. During the 1910 season, the Mids didn't give up a point and posted an 8-0-1 record. The only blemish — a 0-0 tie with Rutgers. That year, Navy beat Army 3-0 thanks to Jack Dalton, who missed his first six field goal attempts before finally hitting the game winner. Navy's last shutout was Sept. 18, 2004, when the Mids blanked Tulsa, 29-0.

## JACK STEPHENS FIELD

The United States Naval Academy Campaign: Leaders to Serve the Nation received a \$10 million gift from Mr. Jackson T. Stephens of Little Rock, Arkansas, in the fall of 2003. Mr. Stephens is a 1947 graduate of the Naval Academy and chairman of Stephens Group, Inc. His gift supported the ongoing renovations at Navy-Marine Corps Memorial Stadium. The field at Navy-Marine Corps Memorial Stadium was named "Jack Stephens Field" in honor of the donor.

## TECUMSEH

The familiar Native American figurehead facing Bancroft Hall and Tecumseh Court has been an Annapolis resident since 1866. Originally, the figurehead of the USS Delaware was meant to portray Tamanend, the great chief of the Delawares. It developed that Tamanend was a lover of peace and did not strike the fancy of the Brigade. Looking for another name, Midshipmen referred to the figurehead as Powhatan and King Philip before finally settling on Tecumseh, the fierce Shawnee chieftain who lived from 1768-1813. The original wooden statue was replaced after some 50 years in the open weather by a durable bronze replica, presented by the Class of 1891. Before Army-Navy competition in any sport, Tecumseh gets a fresh coat of war paint. He is also the target of left-handed salutes and a shower of pennies — offerings for victory.

## UNIFORMS

In 1879, the Navy team wore canvas jackets, laced tight around their bodies. These were supposedly the first real uniforms ever used.



*Tecumseh*

# CHET GLADCHUK

## DIRECTOR OF ATHLETICS



In four years on the job, Naval Academy Director of Athletics Chet Gladchuk has overseen a renaissance of Navy athletics.

Last fall, the Navy football team completed one of its most successful seasons in school history as the Midshipmen recorded a 10-2 record, won the

Commander-In-Chief's Trophy for the second-consecutive year and won the Emerald Bowl. The 10 wins equaled the most in school history and were the most wins in 99 years, while it was just the second time in school history that Navy has won the Commander-In-Chief's Trophy two-straight years. Navy ended the year ranked 24th in the country in both polls, marking the first time since 1978 that the Midshipmen finished the year ranked in the top 25. Head coach Paul Johnson was named National Coach of the Year by the Bobby Dodd Foundation.

The football team wasn't the only successful squad at the Naval Academy as Navy athletic teams won 62 percent of their contests (284-174-6) during the 2004-05 academic year. Twelve Midshipmen garnered All-America honors, while six different



teams won conference championships. The rifle (fifth at the NCAA Championship), wrestling (33rd at the NCAA Championship) and lacrosse teams (NCAA Quarterfinals) joined the football squad in bringing national recognition to the Naval Academy. Two Navy athletic teams performed in front of record crowds as the football team drew a school record 186,099 fans to Navy-Marine Corps Memorial Stadium, while the lacrosse team ranked No. 1 in the nation in averaged attendance (6,526). Navy athletics was also successful in the classroom, ranking No. 1 in the country in the NCAA's Academic Progress Report among the 117 schools with Division IA football programs. Navy was No. 7 overall out of 328 Division I institutions and first among the three service academies. Gladchuk was able to parlay Navy's athletic success into an exclusive television deal with College Sports Television that will significantly increase Navy's television exposure over the next five years. CSTV, the first 24-hour college sports network, will televise every Navy home and select neutral site football games (excluding Notre Dame and Army which will be televised nationally by CBS), as well as other Navy men's and women's athletic events, original programming and documentaries centered around the storied Navy athletic program starting next fall. The long-term multi-media agreement includes internet streaming, broadband and video-on-demand rights and high definition rights starting in 2006. A major part of the agreement was that all home football games would be played on Saturday for the convenience of the Navy Alumni.

Gladchuk also added radio giant WBAL (1090) in Baltimore to Navy's radio network. WBAL Radio, which is also the voice of the Baltimore Orioles, is Maryland's dominant and most powerful radio station. Since 1925, generations of Marylanders have turned to WBAL Radio for news, weather, thought-provoking discussions and sports. As Maryland's

### 2004-05 NAVY ATHLETICS: A SEASON TO REMEMBER

#### OVERALL RECORD

284-174-6 (.623)

#### N-STAR RECORD VS. ARMY

12-9-1 (.568)

#### 12 ALL-AMERICANS

#### FOUR ACADEMIC ALL-AMERICANS

#### EIGHT CONFERENCE ATHLETES OF THE YEAR

#### ONE NATIONAL COACH OF THE YEAR

Paul Johnson-Football

#### FIVE CONFERENCE COACHES OF THE YEAR

#### SIX CONFERENCE CHAMPIONSHIPS

#### NATIONAL HONORS

Ranked No. 1 in the nation among all Division IA Schools in the APR

Football-Emerald Bowl Champions, ranked 24th in the nation

Rifle-Fifth at the NCAA Championship

Wrestling-33rd at the NCAA Championship

Lacrosse-Advanced to the Elite Eight

only 50,000-watt AM station, WBAL's signal travels substantially further than any other station in the state.

Since being introduced as the Academy's 28th Director of Athletics on Sept. 4, 2001, Gladchuk has hit the ground running. From the hiring of Paul Johnson as head football coach to the renovation of Navy-Marine Corps Memorial Stadium, Gladchuk has made improvements in several key areas that will prove more success on the athletic fields for years to come.

In Gladchuk's first-four years at the Naval Academy, he has seen Navy teams win 59 percent of their contests. The baseball, lacrosse (twice), women's soccer, men's swimming & diving (twice), men's indoor track & field (twice), women's outdoor track & field, golf, women's soccer (three times), rifle (four times), sprint football (three times), women's crew and water polo (twice) teams all have won conference titles over the past four years, while the baseball, golf, lacrosse (twice), rifle (four times), women's soccer, men's swimming & diving and water polo teams have advanced to the NCAA Tournament during his tenure at the Academy. In addition, the football team has gone to two bowl games.

Gladchuk has also worked tirelessly to bring back school spirit, working in conjunction with school officials to encourage midshipmen to attend events for all sports.

Gladchuk immediately embraced the local community and alumni base, and is an often-requested speaker. His regular 'Ask the AD' column on navysports.com is one of the most popular features on Navy's internet site.

Gladchuk's biggest impact on the Academy in his first year was the hiring of Paul Johnson as a head football coach. Johnson came to the Naval Academy from Georgia Southern where he posted a 62-10 (.861) record, won two-straight I-AA National Championships (1999 and 2000) and was named the Division I-AA National Coach of the Year four-consecutive times (1997-2000).

After hiring Johnson, Gladchuk set his sights on Navy-Marine

Corps Memorial Stadium where he completely refurbished the football stadium over a four-year time frame. The addition of 6,500 permanent seats on the sidelines and in the end zones, luxury boxes, dropping the field eight feet and moving the sidelines closer, two video scoreboards, a memorial plaza, upgraded restroom and concession areas, a perimeter walking path, new lighting, a new sound system, landscaping the grounds and storm water management highlight the list of renovations. Gladchuk has worked closely with the city, county, state and neighborhood associations to ensure proper communication and sensitivity to issues that benefit both the NAAA and community at large.

Gladchuk and the NAAA were awarded the Green Star award by Annapolis Mayor Ellen Moyer for commitment to the environment during the ongoing renovation of Navy-Marine Corps Memorial Stadium.

Other highlights of Gladchuk's tenure at the Naval Academy include the renegotiation of the Army-Navy contract through 2009 which will bring over \$25 million to the two schools over the six games, scheduling Maryland and Notre Dame at M&T Bank Stadium in Baltimore to promote Navy football in the community and negotiating the extension of the Navy-Notre Dame football game television contract with CBS through 2008.

Gladchuk is also Chairman of the Executive Committee in the Patriot League and is on the NCAA Olympic Sport Liaison Committee.

Gladchuk came to the Naval Academy from the University of Houston, where he had been the Director of Athletics since July 18, 1997. Recognized as one of the nation's top leaders in intercollegiate athletics management, he guided the Cougars to 19 Conference USA Championships, while making significant strides in the academic success of their student-athletes, gender equity and fiscal management.

Gladchuk came to Houston after serving more than seven years as the Director of Intercollegiate Athletics, Intramurals and Recreation at his alma mater, Boston College. Under Gladchuk, Boston College emerged as one of the NCAA's elite programs of the 1990s. The school's graduation rate for all student-athletes was over 90 percent and the Eagles won the College Football Association's Academic Achievement Award for the highest graduation rates among all Division I schools in three of his last five years at Boston College.

Prior to rejoining Boston College, Gladchuk served as AD at Tulane University from 1987-90. During his tenure, he directed the reinstatement of the Green Wave basketball program to Division I status. In addition, he oversaw the construction of new facilities for the athletics administration as well as baseball, track and field and tennis teams after a \$25 million athletics campaign was successfully completed.

From 1985-87, he served as Associate AD at Syracuse University, heading operations, NCAA compliance, financial aid and facility operations. Gladchuk lettered in football at Boston College and graduated with honors in business management in 1973. He earned a master's in sports administration from the University of Massachusetts-Amherst in 1974, where he began his career in intercollegiate athletics, including serving for seven years as Director of General Physical Education, Assistant and Associate Athletic Director for the university. He also has served as Director of Athletics and head football coach for the New Hampton (Prep) School in New Hampshire prior to leaving for UMass.

He and his wife, Kathy, have four children: John, a graduate of Loyola Marymount; Katie, a graduate of Boston College; Christie, a graduate of Trinity and Julie, who is a junior at North Carolina and a member of the women's lacrosse team.

## PAST ATHLETIC DIRECTORS

Harris Laning 1895	1910-12
Arthur P. Fairchild '01	1912-15
Charles Earle Smith '03	1915-17
William F. Halsey Jr. '04	1917-18
Douglas L. Howard '06	1918-23
Byron McCandless '05	1923-25
Jonas H. Ingram '07	1925-30
Henry D. Cook Jr. '03	1930-31
John W. Wilcox Jr. '05	1931-34
Robert C. Giffen '07	1934-37
Ernest W. McKee '08	1937-40
Thomas S. King II '11	1940-42
Harvey E. Overesch '15	1942
Lyman S. Perry '20	1942-43
John E. Whelchel '20	1943-44
Harles O. Humphreys '22	1944-46
Edmund B. Taylor '25	1946-48
Thomas J. Hamilton '27	1948
Henry H. Caldwell '27	1949-51
Ian C. Eddy '30	1951-54
Charles Elliott Loughlin '33	1954-57
Slade Cutter '35	1957-59
Asbury Coward '38	1959-62
William S. Busik '43	1962-65
Alan R. Cameron '44	1965-68
J. O. Coppedge '47	1968-88
Jack Lengyel	1988-2001
Chet Gladchuk	2001-present

# THE NAVAL ACADEMY ATHLETIC ASSOCIATION

The Naval Academy Athletic Association (NAAA), founded in 1891 by Robert Means Thompson, is a non-profit organization whose objective is to "promote, support and assist in financing the athletic contests of the Midshipmen of the United States Naval Academy" in accordance with the policy of the Superintendent of the Academy.

Through an intercollegiate athletic program, which is one of the largest in the country, and a highly-organized intramural and club sports program run by the Naval Academy, each midshipman is afforded the opportunity to compete in athletics at a level commensurate with his or her abilities. The emphasis on physical fitness is borne out in the first line of the mission of the Naval Academy: To develop midshipmen morally, mentally and physically.

The NAAA's presence on the grounds of the Naval Academy was established by Public Law 75-50 of March 26, 1938. Under the terms of that law, the Superintendent of the Academy was authorized to accept gifts and bequests of money from the Navy Athletic Association (as the NAAA was then named) and the Naval Institute to use that money to construct a building for use as a United States Naval Academy Museum on land owned by the United States. Thus, Preble Hall was erected at the Naval Academy. That same public law authorized the Secretary of the Navy to accept the building and to use and maintain such building as the Naval Academy Museum and for the administrative offices of the Navy Athletic Association and the Naval Institute. NAAA later moved to Ricketts Hall.

NAAA funds are generated through admissions charged for intercollegiate athletic contests, appearances by Navy teams on television, from dues and gifts from members of the association and from interest on invested funds. All revenue received by the NAAA is committed to the support of the Academy's intercollegiate athletic program.

The NAAA arranges the schedules for intercollegiate athletics, including the 30 varsity sports (21 for men, nine for women) and nine plebe/junior varsity teams, provides coaching staffs and equipment and maintains a central office to handle the administrative details of the athletic program.

The NAAA is governed by an Athletic Board of Control composed of seven members, chaired by the Commandant of Midshipmen, and reporting to the Superintendent of the Academy. The other members are the President (Director of Athletics) and Vice President of the NAAA (Deputy Director of Athletics), two members of the faculty and staff at the Naval Academy as appointed by the Superintendent; an Officer Representative for a varsity athletic team, who shall be recommended by the Director of Athletics and appointed by the Commandant of Midshipmen; and the Institutional Athletic Representative to the NCAA who shall be appointed by the Superintendent.

All negotiations, plans, appointments and acts of the NAAA which affect the Naval Academy athletic program are subject to the review and approval of the NAAA Board of Control and the Superintendent of the Naval Academy.

The NAAA is headed by the Director of Athletics and his staff members which include the Deputy Director of Athletics (an active duty Naval Officer), the Associate Directors of Athletics and Assistant Directors of Athletics, who are responsible for the finances of the association, compliance with NCAA rules, promotion and publicity, operations, scheduling, admissions and academic support of the intercollegiate athletic program.

Membership in the NAAA can be obtained by joining our Blue & Gold Club. Currently there are 6,500 alumni, naval officers and

## OFFICERS OF THE NAAA

**PRESIDENT • CHET GLADCHUK**

**VICE PRESIDENT • CAPT. GREG COOPER, USN**

**SECRETARY • CARL TAMULEVICH**

**TREASURER • BARBARA BROZEN**

friends of Navy athletics. The membership was opened to all interested parties in the early 1980s. In 2004 it changed its name to "The Blue & Gold". The intention and mission of this vehicle for giving remains the same, as has been the case for more than 113 years - supporting the Brigade of Midshipmen in intercollegiate athletics.

The mission is simple: We expect to win in everything we do - on and off the field of competition. The Blue & Gold provides the supplemental resources necessary to assist our coaches and midshipmen to realistically pursue the highest level of success with the context of their physical challenges. We are an institution invested in a mission that educates future leaders in moral, mental and physical excellence. The Blue & Gold enables our midshipmen to pursue the highest goals possible as members of varsity or junior varsity teams.

The Naval Academy Athletic Association operates and maintains the Navy-Marine Corps Memorial Stadium and the Naval Academy Golf Course and coordinates the use of such other athletic facilities as Alumni Hall for basketball; Halsey Field House for track and field and wrestling; Lejeune Hall for swimming, water polo and wrestling; Macdonough Hall for gymnastics and volleyball; Bishop Stadium for baseball; Ingram Field for track and field; the Glenn Warner Soccer Stadium and Rip Miller field, an all-purpose practice facility used by lacrosse and football.

Since 1924, the NAAA has invested in many permanent projects at the Naval Academy. The NAAA's interests relate not only to athletics, but to the overall quality of life enhancing the training and development of the Midshipmen



# NAAA EXECUTIVE ATHLETIC COUNCIL



**Dr. Roger Little**  
NCAA Faculty  
Athletic Representative



**Capt. Greg Cooper, USN**  
Deputy Director of  
Athletics



**Eric Ruden**  
Senior Associate AD  
External Relations



**Dave Smalley**  
Senior Associate AD  
Admissions, Acad., Compliance



**Barbara Brozen**  
Associate AD  
Business Affairs



**Dave Davis**  
Associate AD • Compliance,  
Admissions, Academics



**Allan Heinze**  
Associate AD  
Operations



**Carl Tamulevich**  
Associate AD  
Scheduling & Team Support



**Jason Boothe**  
Assistant AD  
Operations



**Mike Brass**  
Assistant AD  
Sport Performance



**Carla Criste**  
Assistant AD  
Senior Women's Admin.



**Loretta Lamar**  
Assistant AD  
NCAA Compliance & Eligibility



**Matt Munnely**  
Asst. AD • Ticket Oper. &  
Summer Sports Camp Prog.



**Tom Schemmel**  
Assistant AD  
Golf Course & Grounds



**Kevin Sinnett**  
Assistant AD • Academic  
and Admin. Affairs



**Scott Strasemeier**  
Assistant AD  
Sports Information



**Chauncey Winbush**  
Assistant AD  
Business Affairs



**Pat Phillips**  
Executive Associate to  
the Director of Athletics

# SAILING TRADITION AT NAVY

The U.S. Navy has long understood knowledge, confidence and respect for the sea instilled through sailing helps to make better naval officers. Therefore, the U.S. Naval Academy's sailing program is second to none. Sailing opportunities at the Academy range from the basic sail training given during the summer to every incoming plebe, to the Command and Seamanship Training Squadron during summer training, to the pinnacle of the sport, the varsity intercollegiate and offshore teams. When you join the Naval Academy sailing team, you are joining a program that has a tradition of helping an individual find out exactly how good he or she can be.

The sailing team is headquartered in the Robert Crown Center, a modern building on the banks of the Severn River. It houses the administrative and coaching offices, team classrooms, locker rooms and equipment repair and storage facilities. The Robert Crown Center also houses the Intercollegiate Yacht Racing Association Hall of Fame which exhibits many of the North American collegiate trophies, plaques and half-models, as well as the All-America lists, representing the achievements of the 70 years of intercollegiate sailing. In addition, the Naval Academy's sailing trophies and awards are on display in the Hall.

Adjacent to the Crown Center is Santee Basin, the mooring area for the Naval Academy's 250-plus sail training fleet including the 20 Navy 44s, six donated offshore boats, 12 J-24's, 22 420s, 22 FJs and 136 Lasers used by the sailing teams. Practices and racing take place on the Severn River and the Chesapeake Bay.



*The Robert Crown Sailing Center at the United States Naval Academy*